

## Lynx Power In M8 and M10

# Table of Contents

<b>1. Safety Precautions</b> .....	<b>1</b>
1.1. Safety Warnings Lynx Distribution System .....	1
1.2. Transport and Storage .....	1
<b>2. Introduction</b> .....	<b>2</b>
2.1. The Lynx Power In .....	2
2.2. The Lynx Distribution System .....	3
<b>3. Features</b> .....	<b>4</b>
3.1. Internal parts and wiring diagram Lynx Power In .....	4
<b>4. System Design</b> .....	<b>6</b>
4.1. Lynx distribution system parts .....	6
4.1.1. Interconnecting Lynx modules .....	6
4.1.2. Orientation of Lynx modules .....	8
4.1.3. System Example - Lynx Power In only .....	8
4.1.4. System example - Lynx Shunt VE.Can, Lynx Power In, Lynx Distributor and lead acid batteries .....	9
4.2. System sizing .....	9
4.2.1. Current rating Lynx modules .....	9
4.2.2. Fusing .....	9
4.2.3. Cabling .....	9
<b>5. Installation</b> .....	<b>10</b>
5.1. Mechanical connections .....	10
5.1.1. Lynx module connection features .....	10
5.1.2. Mounting and interconnecting Lynx modules .....	10
5.2. Electrical connections .....	11
5.2.1. Connect DC wires .....	11
5.2.2. Ground and Negative connections .....	11
5.2.3. Positive connections .....	13
<b>6. Commissioning the Lynx Power In</b> .....	<b>15</b>
<b>7. Troubleshooting and Support</b> .....	<b>16</b>
7.1. Cabling issues .....	16
<b>8. Technical specifications Lynx Power In</b> .....	<b>17</b>
<b>9. Enclosure dimensions Lynx Power In M8 and M10</b> .....	<b>18</b>

# 1. Safety Precautions

## 1.1. Safety Warnings Lynx Distribution System



- Do not work on live busbars. Ensure that the busbar is unpowered by disconnecting all positive battery poles prior to removing the Lynx front cover.
- Work on batteries should be carried out by qualified personnel only. Observe the battery safety warnings as listed in the battery manual.

## 1.2. Transport and Storage

Store this product in a dry environment.

The storage temperature should be: -40°C to +65°C.

No liability can be accepted for damage in transit if the equipment is not transported in its original packaging.

## 2. Introduction

### 2.1. The Lynx Power In

The Lynx Power In contains a positive and negative busbar with 4 connections for batteries, loads or chargers and a ground connection. It is part of the Lynx Distribution system and is available in two versions, with M8 or M10 busbar. Note that M10 refers to the busbar connection joints where the modules are connected to each other. The fuse and cable connections are always M8.

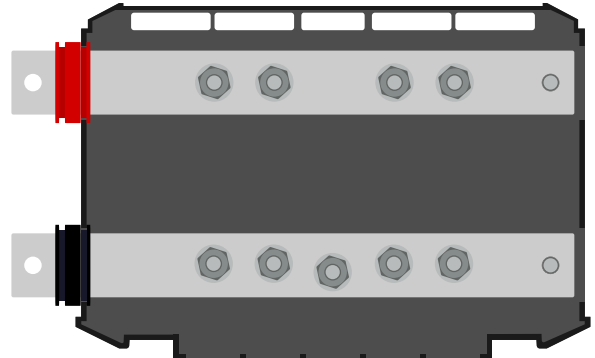
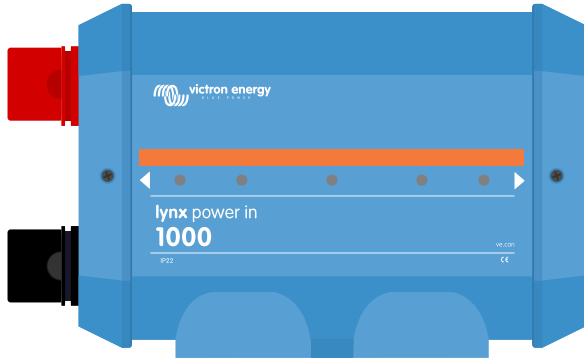

*Lynx Power In - with and without cover*

## 2.2. The Lynx Distribution System

The Lynx Distribution System is a modular busbar system that incorporates DC connections, distribution, fusing, battery monitoring and/or Lithium battery management. For more information, see the [DC Distribution Systems product page](#).

The Lynx Distribution System consist of the following parts:

- **Lynx Power In** - A positive and negative busbar with four batteries or DC equipment connections, available in two versions, with M8 or M10 busbar.
- **Lynx Class-T Power In** - A positive and negative busbar that accepts two Class-T fuses and has two battery or DC equipment connections, available with M10 busbar.
- **Lynx Distributor** - A positive and negative busbar with four fused connections for batteries or DC equipment and fuse monitoring, available in two versions, with M8 or M10 busbar.
- **Lynx Shunt VE.Can** - A positive busbar with a space for a main system fuse and a negative busbar with a shunt for battery monitoring. It has VE.Can communication for monitoring and setup with a GX device. Available in two versions, with M8 or M10 busbar.
- **Lynx Smart BMS** - For use together with Victron Energy Smart Lithium batteries. It contains a positive busbar with a contactor driven by a battery management system (BMS) and a negative busbar with a shunt for battery monitoring. It has Bluetooth communication for monitoring and setup via the VictronConnect App and VE.Can communication for monitoring with a GX device and the VRM portal. Available as a 500A model with M8 or M10 busbars or 1000A model with M10 busbars.

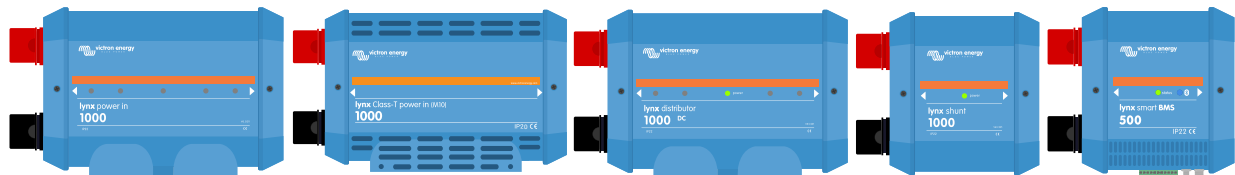

The Lynx modules: Lynx Power In, Lynx Class-T Power In, Lynx Distributor, Lynx Shunt VE.Can and Lynx Smart BMS

## 3. Features

### 3.1. Internal parts and wiring diagram Lynx Power In

The internal physical parts and the wiring diagram of the Lynx Power In indicating the following parts:

- Positive busbar
- Negative busbar
- Positive connections
- Negative connections
- Ground connection

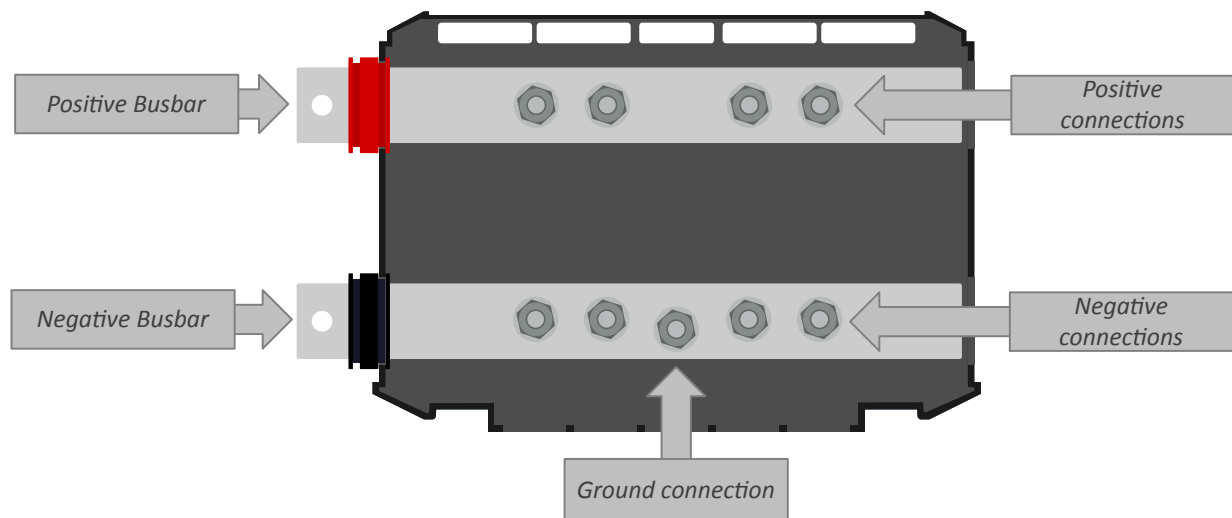

*The internal physical parts of the Lynx Power In*

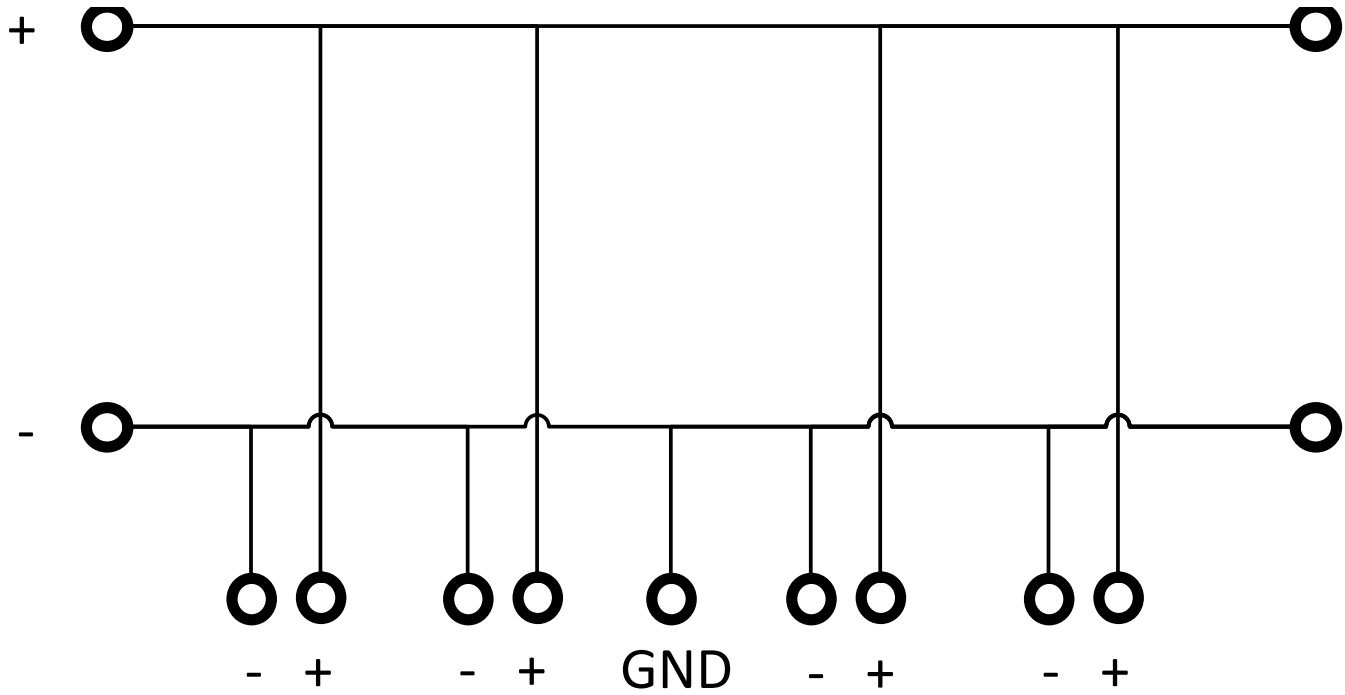

*The internal wiring diagram of the Lynx Power In*

## 4. System Design

### 4.1. Lynx distribution system parts

A Lynx distribution system usually consists of a single Lynx Shunt VE.Can module or a single Lynx Smart BMS module.

The choice between a Lynx Shunt VE.Can or a Lynx Smart BMS depends on what type of batteries are used in the system. The Lynx Smart BMS can only be used with the Victron Energy [Lithium Smart Batteries](#), while the Lynx Shunt VE.Can is suitable for all other batteries.

Then, single, multiple or a combination of Lynx Distributor modules and/or Lynx Power In/Lynx Class-T Power In modules are added.

Together they form a continuous negative and positive busbar with DC connections and, depending on the configuration, integrated fuses, a battery monitor and/or lithium battery management.

It is also possible to use Lynx Power In modules and/or Lynx Distributor modules without a Lynx Smart BMS module or a Lynx Shunt VE.Can module. This is for situations where battery monitoring or battery management is not needed.

#### 4.1.1. Interconnecting Lynx modules

Each Lynx module can be connected to other Lynx modules on the left and right. Note that M10 modules cannot be connected directly to M8 modules and vice versa.

If the Lynx module is the first in line, the last in line or is used by itself, it is possible to connect batteries, loads or chargers directly to these connections. Please note that additional fusing may be required if batteries and loads are connected directly to the interconnections.

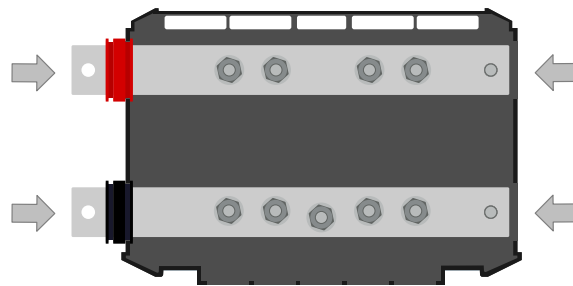

Lynx connections: The arrows indicate where the other Lynx modules can connect

The example below shows a Lynx system consisting of a Lynx Power In, Lynx Shunt VE.Can and Lynx Distributor. Together, they form a continuous busbar with unfused battery connections, battery monitor, main system fuse and fused load connections.

**Figure 1. Example of Interconnected Lynx modules without their covers (Lynx Shunt VE.Can)**

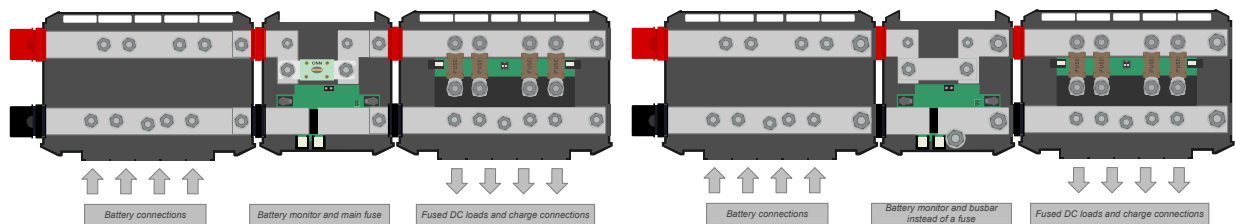

Interconnected Lynx modules: Lynx Power In, Lynx Shunt VE.Can and Lynx Distributor. On the right the M10 variant with busbar instead of the fuse

The example below shows a Lynx system consisting of a Lynx distributor, Lynx Smart BMS and another Lynx Distributor. Together, they form a continuous busbar with fused battery and load connections, battery monitor, BMS system and contactor.



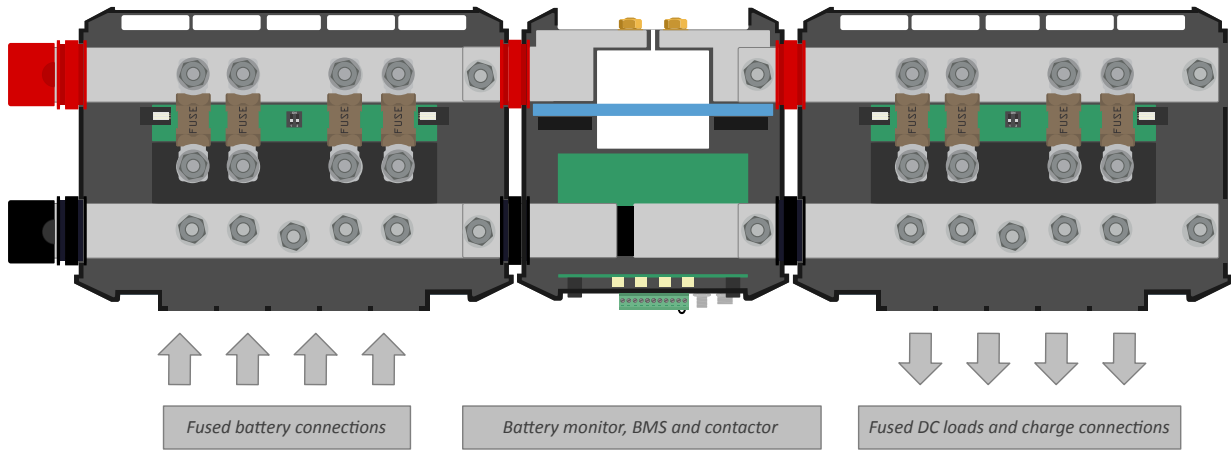

*Interconnected Lynx modules: Lynx Distributor, Lynx Smart BMS and another Lynx Distributor*

### 4.1.2. Orientation of Lynx modules

If the Lynx System contains a Lynx Shunt VE.Can or Lynx Smart BMS, the batteries always have to be connected to the left side of the Lynx System and the rest of the DC system (loads and chargers) connect to the right side. This so the battery state of charge can be correctly calculated.

The Lynx modules can be mounted in any orientation. Should they be mounted upside down so that the text on the front of the units is upside down as well, use the special stickers included with each Lynx module so that the text is orientated the correct way.

### 4.1.3. System Example - Lynx Power In only

In this system a Lynx Power In is used by itself. Multiple Lynx Power In modules can be connected to each other thus creating a longer busbar with more connections for batteries and/or loads.

The Lynx Power In does not contain fuses. All connected loads, chargers or batteries need to be fused externally.

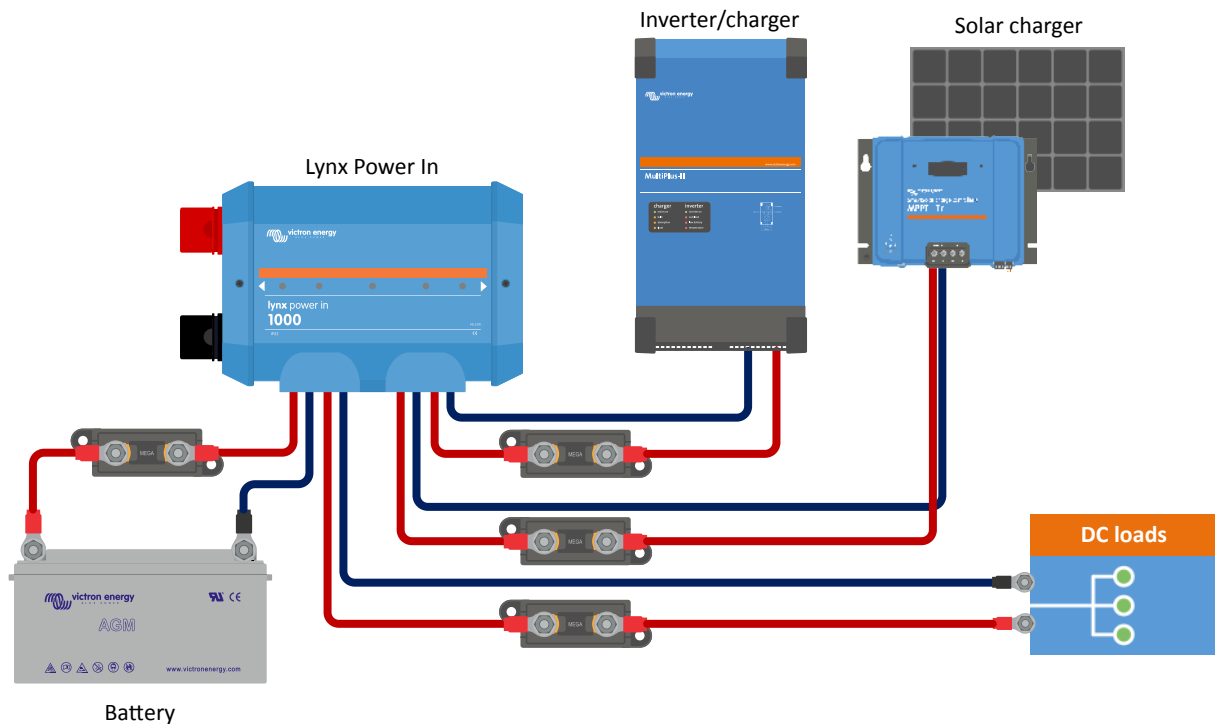

System with a Lynx Power In only

#### 4.1.4. System example - Lynx Shunt VE.Can, Lynx Power In, Lynx Distributor and lead acid batteries

This system contains the following components:

- Lynx Power In with 4 paralleled 12V lead acid batteries.
- Identical cable lengths for each battery.
- Lynx Shunt VE.Can with main system fuse and battery monitor.
- Lynx Distributor with fused connections for inverter/charger(s), loads and chargers. Note that additional modules can be added if more connections are needed.
- Cerbo GX (or other GX device) to read out the battery monitor data.

*System with Lynx Shunt VE.Can, lead acid batteries and a Lynx Distributor*

*System with Lynx Shunt VE.Can, lead acid batteries and a Lynx Distributor*

## 4.2. System sizing

### 4.2.1. Current rating Lynx modules

The Lynx Distributor, Lynx Shunt VE.Can, Lynx Class-T Power In and the Lynx Power In are rated for a nominal current of 1000A for 12, 24 or 48 System voltages.

See the table below for an idea of how much power the Lynx modules are rated at different voltages. The power rating will indicate how big the connected inverter/charger system can be. Remember that if inverters or inverter/chargers are used, the batteries will power both the AC and DC systems. Also, be aware that a Lynx Smart BMS or a Lynx Ion (now discontinued) can have a lower current rating.

	12V	24V	48V
1000A	12kW	24kW	48kW

### 4.2.2. Fusing

The Lynx Power In does not have spaces for fuses, fusing needs to be done externally. For more information on fuses and fuse holders, see the [Fuses & Fuse holders product page](#).

Always use fuses with the correct voltage and current rating. Match the fuse rating to the maximum voltages and currents that potentially can occur in the fused circuit. For more information on fuse ratings and fuse current calculations see the [Wiring Unlimited book](#).



The total value of the fuses of all circuits should not be more than the current rating of the Lynx module or the Lynx model with the lowest current rating in case of multiple Lynx modules are used.

### 4.2.3. Cabling

The current rating of the wires or cables used to connect the Lynx Power In to batteries and/or the DC loads, has to be rated for the maximum currents that can occur in the connected circuits. Use cabling with a sufficient core surface area to match the maximum current rating of the circuit.

For more information on cabling and cable thickness calculations, see our book, [Wiring Unlimited](#).

## 5. Installation

### 5.1. Mechanical connections

#### 5.1.1. Lynx module connection features

The Lynx module can be opened up by unscrewing the 2 cover screws.

The contacts on the left side are covered by a removable rubber sleeve.

Red is the positive and black is the negative busbar.

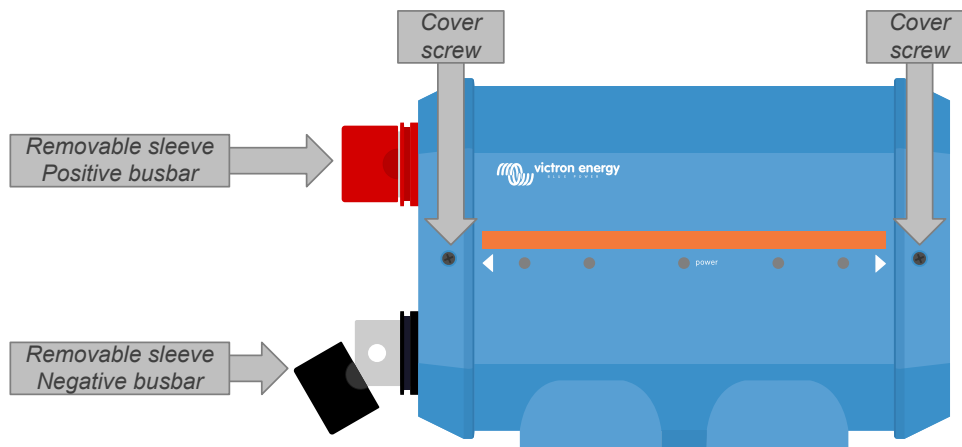

Location of front cover screws and the removable sleeves

#### 5.1.2. Mounting and interconnecting Lynx modules

This paragraph explains how to attach several Lynx modules to each other and how to mount the Lynx assembly into its final location.

For a mechanical drawing of the housing with dimensions and the location of the mounting holes, see the [Enclosure Dimensions](#) of this manual.

These are the points to take into consideration when interconnecting and mounting Lynx modules:

- If Lynx modules are going to be connected to the right and if the Lynx module is fitted with a plastic barrier on the right side, remove the black plastic barrier. If the Lynx module is located as the most right module, leave the black plastic barrier in place.
- If Lynx modules are going to be connected to the left, remove the red and black rubber sleeves. If the Lynx module is located as the most left module, leave the red and black rubber sleeves in place.
- If the Lynx system contains a Lynx Smart BMS or Lynx Shunt VE.Can, the left side is the battery and the right side is the DC system side.
- Connect all Lynx modules to each other using the M8 (M10) holes and bolts on the left and right. Take care that the modules are correctly slotted into the rubber joiner recesses.
- Place the washer, spring washer and nut on the bolts and tighten the bolts using a torque of:
  - M8 Model: 14Nm**
  - M10 Model: 33Nm (17Nm for units with a serial number before HQ2340XXXX)**
- Mount the Lynx assembly in its final location using the 5mm mounting holes.

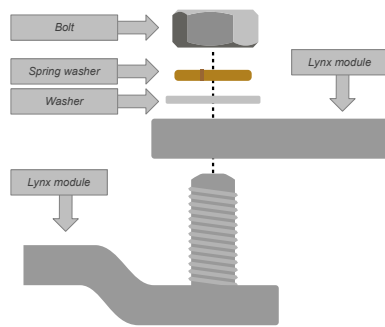
**Figure 2. Connection sequence when connecting two Lynx modules**

Correct placement of the M8 (M10) washer, spring washer and nut.

## 5.2. Electrical connections

### 5.2.1. Connect DC wires

This chapter might not apply if the Lynx module is connected to other Lynx modules like this can be the case for the Lynx Smart BMS or the Lynx Shunt VE.Can.

For all DC connections, the following applies:

- All cables and wires connected to the Lynx module need to have been fitted with M8 cable lugs.
- Pay attention to the correct placement of the cable lug, washer, spring washer and nut on each bolt when attaching the cable to the bolt.
- Tighten the nuts using a torque of:

**M8 Model: 14Nm**

**M10 Model: M10 nuts: 33Nm (17Nm for units with a serial number before HQ2340XXXX) - M8 nuts: 14Nm**

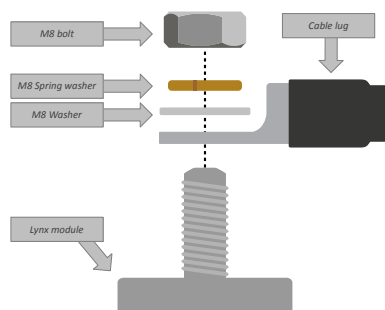
**Figure 3. Correct mounting sequence DC wires**

Correct placement of the M8 Cable lug, washer, spring washer and nut

### 5.2.2. Ground and Negative connections

#### Connect the ground wire

This only applies if the system requires a ground connection. There should only be one ground connection per system. The ground connection should be made after the Lynx Smart BMS, Lynx Shunt VE.Can or battery monitor shunt. For more information on system grounding, see the [Wiring Unlimited book](#).

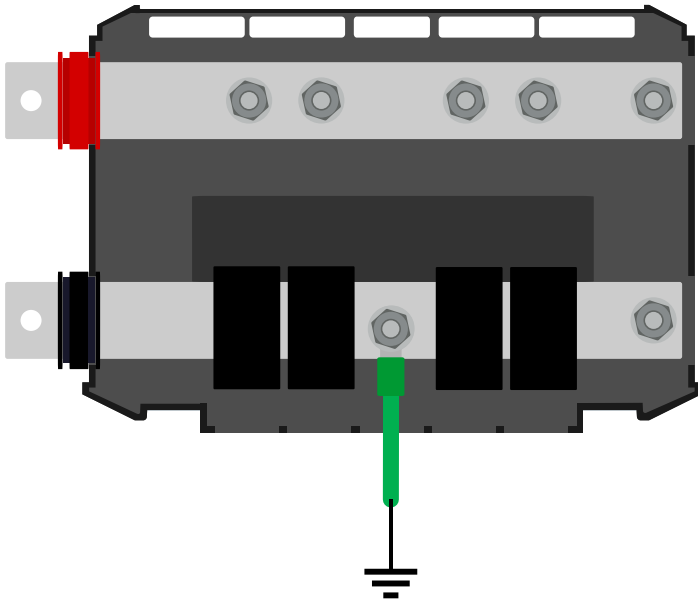

Ground connection Lynx power In

**Connect the negative wires**

Remove the cable separator post if the wire diameter exceeds 10mm.

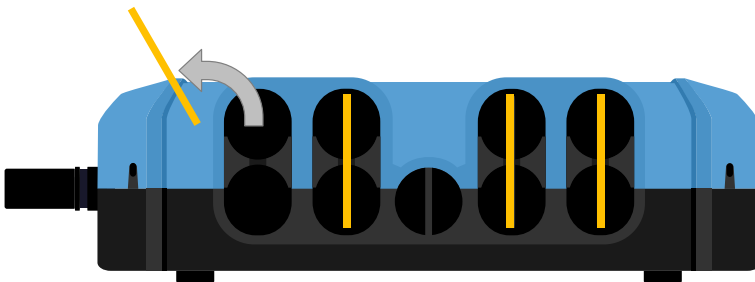

The cable separator posts are indicated in yellow

To reach the negative connections, swing the black cable separators upwards. The black cable separators can be temporarily removed by pulling them away from the Lynx Power In at a slight sideways angle in case better access is needed.

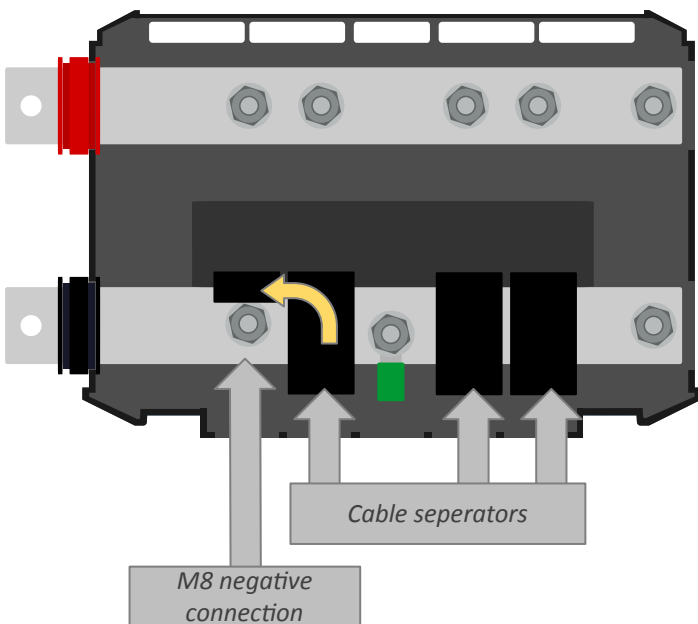

Flip up the cable separator to reach the negative connections

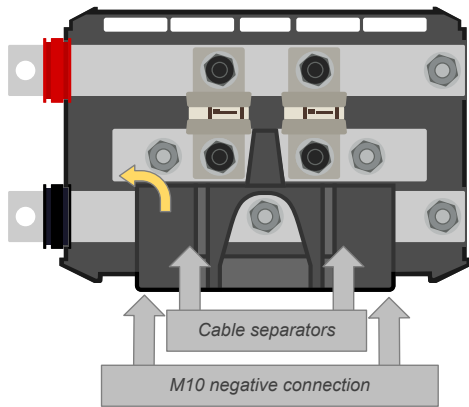

Flip up the cable separator to reach the negative connections

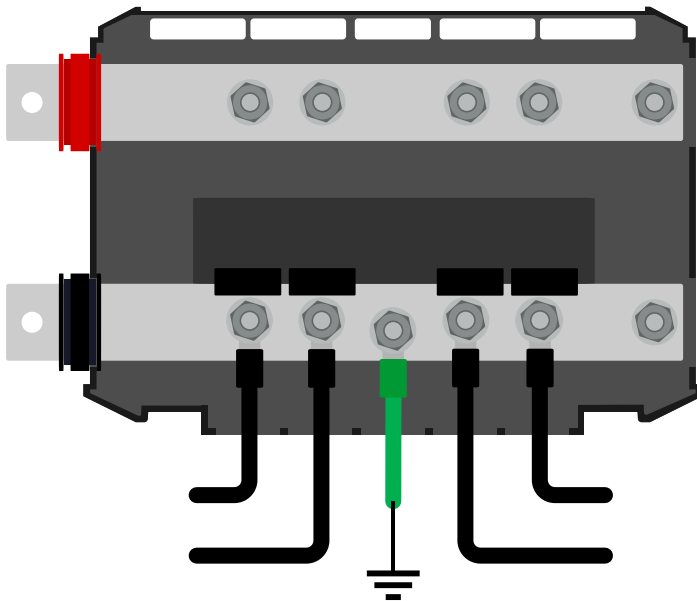

Negative connection Lynx Power In

### 5.2.3. Positive connections



Before making any positive connections, ensure the positive wires are not powered. Disconnect all positive cables from the battery before connecting them to the Lynx module. This to prevent accidental short circuits.

Connect all positive wires.

Power the Lynx system by connecting the positive battery pole(s).

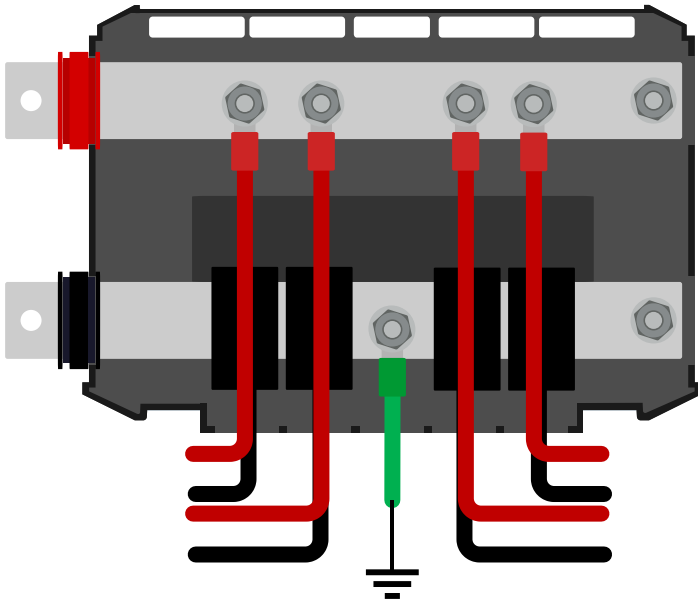

*Connecting the positive wires Lynx Power In*



## 6. Commissioning the Lynx Power In

Commissioning sequence:

- Check polarity of all DC cables.
- Check cross sectional area of all DC cables.
- Check if all cable lugs have been crimped correctly.
- Check if all cable connections are tight (don't exceed maximum torque).
- Tug slightly on each battery cable to check if the connections are tight and if the cable lugs have been crimped correctly.

## 7. Troubleshooting and Support

For unexpected behaviour or suspected product faults, refer to this chapter.

Start by checking the common issues described here. If the problem persists, contact the point of purchase (Victron dealer or distributor) for technical support.

If you're unsure who to contact or if the point of purchase is unknown, refer to the [Victron Energy Support webpage](#).

### 7.1. Cabling issues

#### Cables heat up

This can be caused by a wiring or connection issue. Check the following:

- Check if all cable connections are tightened with a torque moment of 14Nm (17Nm for the M10 model).
- Check if all fuse connections are tightened with a torque moment of 14Nm (17Nm for the M10 model).
- Check if the surface area of the cable core is large enough for the current through that cable.
- Check if all cable lugs have been crimped correctly and are tight enough.

#### Other cabling issues

For additional information about issues that can arise from bad or incorrect cabling, cable connections or wiring of battery banks refer to the [Wiring Unlimited Book](#).

## 8. Technical specifications Lynx Power In

Power	
Voltage range	9 - 60Vdc
Current rating	1000Adc continuous

Connections	
Busbar	M8 or M10

Physical	
Enclosure material	ABS
Enclosure dimensions (hxwxh)	290 x 170 x 80mm
Unit weight	2.1 kg
Busbar material	Tinned copper
Busbar dimensions (hxw)	8 x 30mm

Environmental	
Operating temperature range	-40°C to +60°
Storage temperature range	-40°C to +60°
Humidity	Max. 95% (non-condensing)
Protection class	IP22

## 9. Enclosure dimensions Lynx Power In M8 and M10

