

BATTLE BORN®

Unstoppable Power Solutions

Product Manual and Installation Guide

270 Amp Hour 12 Volt Smart Lithium Battery

Models: BBGC3i / BBGC3iH

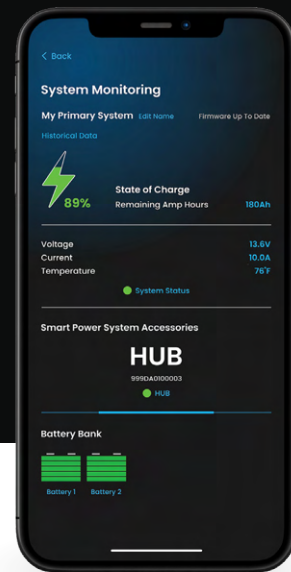
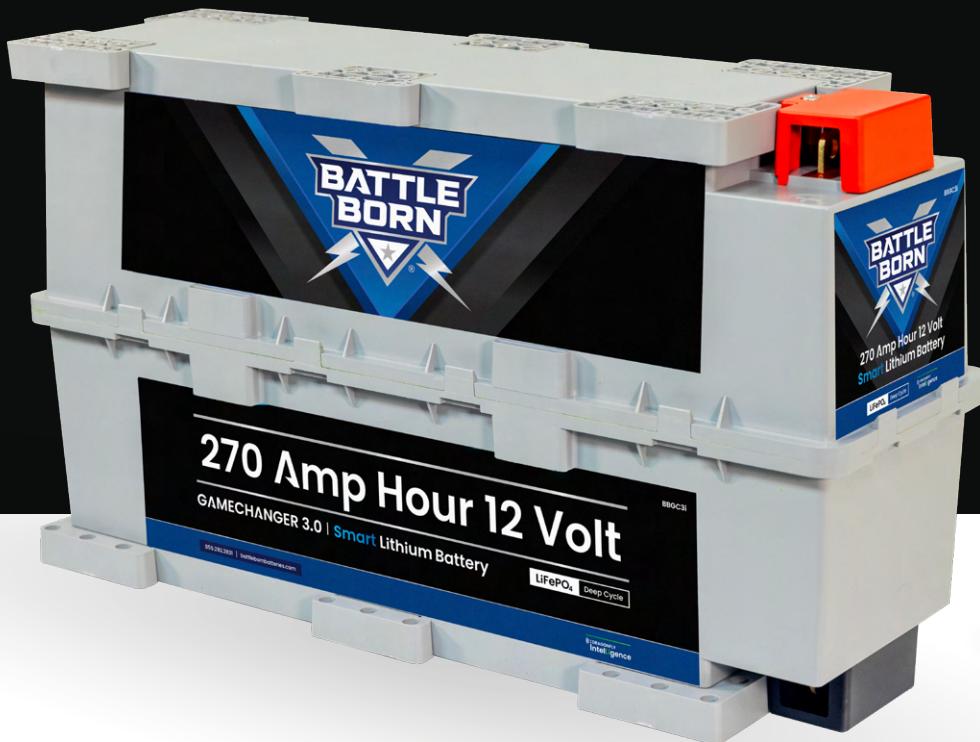

For Technical Support, please contact: 855.292.2831 | info@battlebornbatteries.com

Document Number: PMI_BBGC3i



Revision: 001

Date: 11/25/2024

Product Name and Model

- Battle Born 270 Amp Hour 12 Volt Smart Lithium Battery (BBGC3i)
- Battle Born 270 Amp Hour 12 Volt Smart Heated Lithium Battery (BBGC3iH)

Certifications

	Conforms to: ANSIMEC 60529-2020 and CSA No. 60529:16 (R2021)
	



	Caution: Risk of Fire and Burns. Do Not Open, Crush, Heat Above 150°F, or Incinerate. Follow Manufacturer's Instructions.
---	---

	ATTENTION, Risque d'incendie et de brûlures. Veuillez ne pas ouvrir, percer, ou exposez à une chaleur égal ou supérieur à 66° C. Ne pas mettre dans le feu. Veuillez suivre les instructions du fabricant.
--	--

IEC: 4LFpR26/65-30

Manufacturer Contact Information – Dragonfly Energy

775.622.3448 | info@dragonflyenergy.com | Dragonflyenergy.com

Customer Support – Battle Born

855.292.2831 | info@battlebornbatteries.com | Battlebornbatteries.com

Information About Your System

As soon as you open your product, record the following information and be sure to keep your proof of purchase.

Serial Number: _____

Purchased From: _____

Purchase Date: _____

Welcome to the Battle Born Family!

Thank you for selecting Battle Born Batteries® for your lithium power needs. We appreciate your confidence in our products and are committed to delivering advanced battery systems that meet your energy needs with reliability and performance.

This manual is designed to provide you with essential information for the installation, operation, and maintenance of your battery system. Whether you are a returning customer or using our products for the first time, this guide serves as a valuable resource to help you get the most from your investment.

If you have any questions or require further assistance, please don't hesitate to contact our technical support team.

Table of Contents

Product Overview	4
What is in the Box?	8
Battery Safety	10
Installation Guide	13
Properly Charging the Batteries	15
Parallel Batteries Connection	17
Series Batteries Connection	19
Battery Management System (BMS)	21
Dragonfly Intelligence: Smart Battery Technology	23
Additional System Considerations	35
Storage, Maintenance, Recycling & Disposal	38
Warranty, Returns & Shipping	40

For additional information and the latest technical literature, please refer to our website: battlebornbatteries.com



Product Overview

Features

- UL-Listed Cylindrical Cells
- Safe & Non-Toxic LiFePO₄ Chemistry
- Smart Battery Communication Technology
- Optional Integrated Heating (Model: BBGC3IH)

Performance & Versatility

- Series and/or Parallel Connection
- Wire in Series up to 48V
- No Limit When Wiring in Parallel
- Mount in Any Orientation
- 100% Depth of Discharge
- 3,000-5,000 Deep Discharge Cycles

Certified and Tested To Industry Safety Standards



Internal BMS

Proprietary battery management system (BMS) ensures user safety and product protection.

- High/Low Voltage Protection
- Short Circuit Protection
- High/Low Temperature Protection
- Cold Charging Protection (Low-Temp Cutoff)
- Automatic Cell Balancing at Top of Charge

300 Amps Continuous | 500 Amps Surge for 30 Seconds | 1/2 Second Surge for Loads over 500 Amps

*Note: This built-in protection will reset after five seconds in most fault conditions. Disconnecting the battery from loads will also reset the BMS.

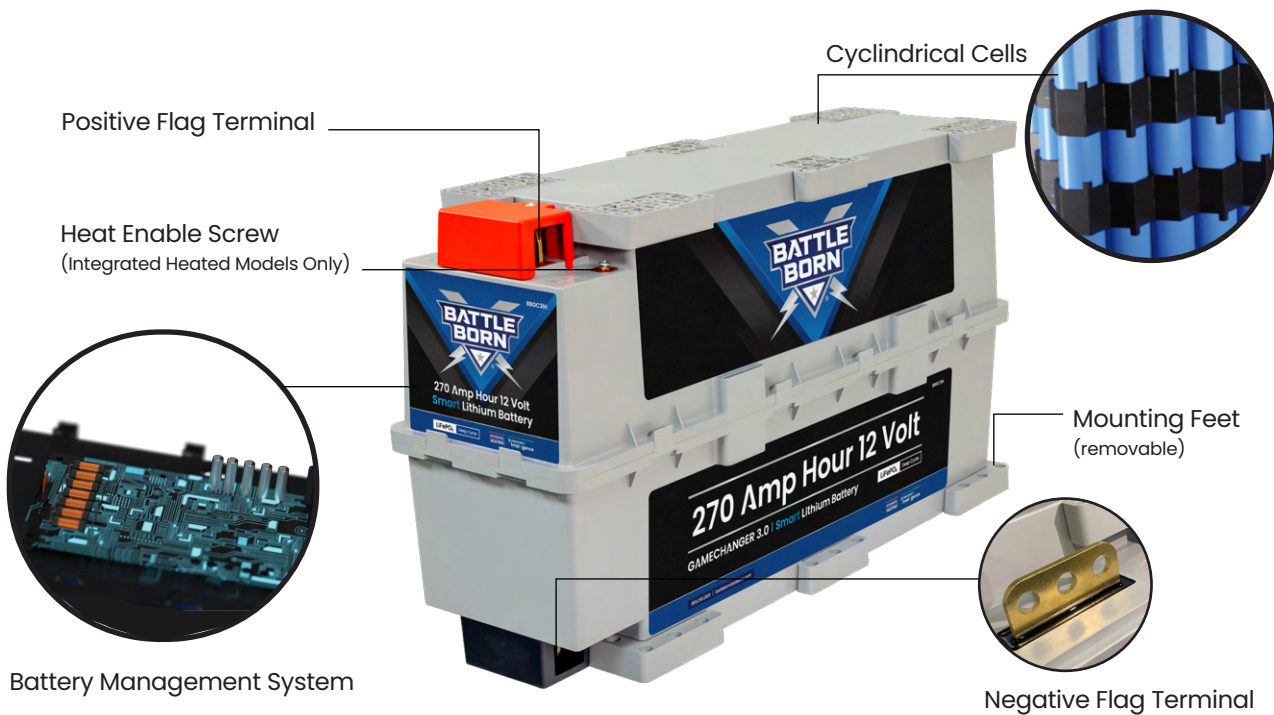

Optional Integrated Heating Technology

All Smart LiFePO₄ Batteries are available in models with optional Integrated Heating technology, which warms the battery pack's internal cells in cold temperatures.

- Allows for Cold Weather Charging
- Low Continuous Power Draw When Enabled
- Integrated Heating Technology Activated at Internal Temperature of ~35°F (*When Heat Function is Enabled)
- Operating Temperature Range of -4°F to 135°F

Note: If you have a heat-enabled model, please refer to the additional Integrated Heating instruction manual prior to use and installation.

INTEGRATED
HEATING

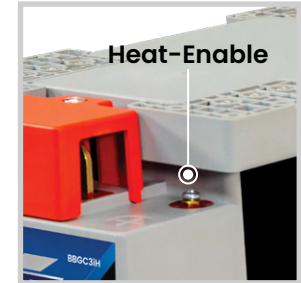

Dragonfly Intelligence® Smart Communication Technology

Dragonfly Intelligence® is the proprietary communication technology inside Battle Born Smart LiFePO₄ Batteries.

- Robust Wireless Mesh Network & Bluetooth® Connectivity
- Quick Setup & Easy Configuration via the Battle Born® Mobile App
- Compatible with RV-C, NMEA 2000 & More (Some Protocols are Coming Soon)
- Remote Monitoring of Individual Batteries or Entire Smart Power System
- Error Detection & Warning Notifications
- Historical Reporting of SOC, Voltage, Performance, System Health & More

DRAGONFLY
Intelligence

Battle Born® Hub

- Connects All Smart Batteries in System
- Receives Wireless Signal from Smart Batteries
- Increases Accessibility to Advanced Communication Features
- Enables Full Power System Monitoring
- Powerful Intermediary Tool for Accessories

Note: A Battle Born Hub is required for Full System Monitoring and Advanced Features.



Battle Born® Mobile App
Available in the iOS App Store.



*Coming soon to Android devices.

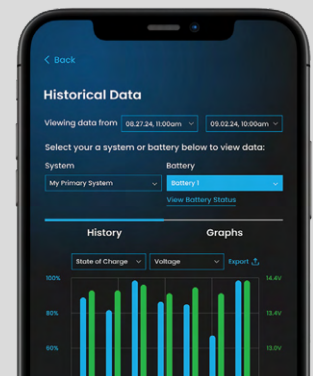

BBGC3i Technical Specifications

Electrical Specifications

Voltage	12V
Capacity	270Ah
Operating Temperature	-4°F to 135°F (-20°C to 57.2°C)
Efficiency	99%
Self Discharge	2-3% per Month
Maximum Series Voltage	48V
Cycle	3K-5K
Built-in BMS	Internal
Resistance	5 mΩ
Usable Depth of Discharge	100%

Discharging Specifications

Max Discharge Current	300A
Peak Discharge Current	500A for 30 Seconds
Surge for Loads Over 500A	.5 Seconds
Recommended Low Voltage Disconnect	10.5V
BMS Discharge Voltage Cut-Off	10V
Reconnect Voltage	10V
Short Circuit Protection	Yes

Recognized Specifications

Battery Cell Certifications	UL 1642
Battery Pack Certifications	UN38.3 IP65 - ANSI/IEC 60529-2020, CSA 60529:16 (R2021) UL 121201:2019, CSA C22.2 No.213-17
Shipping Class	UN3480, Class 9

Temperature Specifications

Discharge Temperature	-4°F to 135°F (-20°C to 57.2°C)
Charge Temperature	25°F to 135°F
Storage Temperature	-10°F to 140°F (-23°C to 60°C)
BMS High Temperature Cut-Off	>135°F
BMS Reconnect Temperature	<135°F

Charging Specifications

Recommended Charge Current	.5C
Max Charge Current	135A
Absorption Voltage	14.2V to 14.6V
Float Voltage	13.4V to 13.8V
Equalization Voltage (if applicable)	14.4V
Absorption Time	100 Minutes per 270Ah Battery Bank
BMS Charge Current Cut-Off	.5C Recommended
Recharge/Rebulk Voltage	13.3V
BMS Cell Balancing Voltage Range	14.2V to 14.6V
High BMS Voltage Protection	14.7VDC
Temperature Compensation	No/Disable

Mechanical Specifications

Dimensions	22.83"L X 7.09"W X 13.15"H
Weight	80.8 lbs.
Terminal Type	.25" Brass
Terminal Hole	3/8" Hole and 3/8" or 5/16" Hardware is Suggested
Terminal Torque	9 to 11 Ft-lb.
Case Material	ABS Fire Rated
Cell Type	Cylindrical
Cell Chemistry	LiFePO4 (Lithium Iron-Phosphate)
Sealed and Water Resistant Case	Non-Submersible

Integrated Heating Specifications (Model BBGC3iH Only)

Heat	Integrated Heating Technology
Heat Enable Terminal	Female M4 Thread
Continuous Power Draw (When Enabled)	28W

Dragonfly Intelligence® Specifications

Discharge Rate of Built-in Communication	10mA Future Firmware Expected to Result in -1-3mA
Bluetooth Range	~15m/50ft
Wireless Mesh Network Range (To Smart Battery)	~10m/32ft
Data Transmission Frequency	5 Seconds

*Note: The storage temperature range is -10°F to 140°F (-23°C to 60°C). We recommend bringing the batteries to a 100% charge and then disconnecting them completely for storage. After six months in storage, your batteries will remain 75 to 80% charged.

Storing batteries in subzero weather (-15°F or more) has the potential to crack the ABS plastic and more importantly could cause a faster loss of capacity, in some cases drastically more than the typical 2 to 4% per month loss.



What is in the Box?

Included with Your Purchase:

- (1) 270 Amp Hour 12 Volt Smart LiFePO₄ Deep Cycle Battery
Model: BBGC3i/BBGC3iH
- (1) Finishing Hardware Kit
 - (2) '18-8 Stainless Steel' 5/16-18 x 1" bolts
 - (2) '18-8 Stainless Steel' 5/16-18 x 1 1/4" bolts
 - (4) Washers
 - (2) Nylok nuts

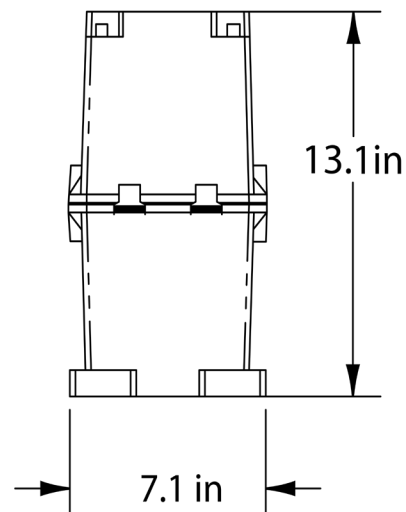
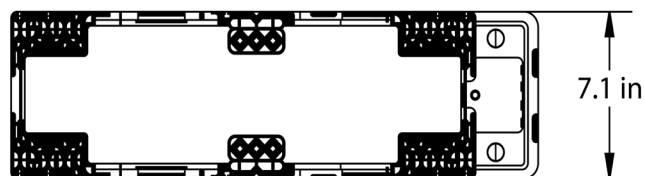
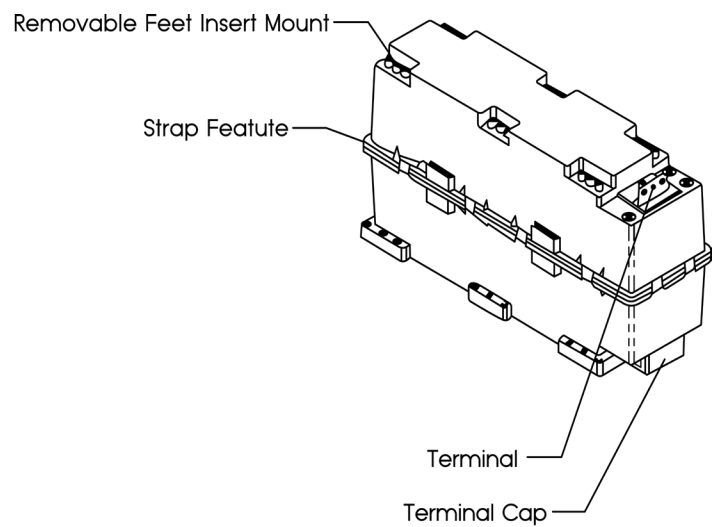
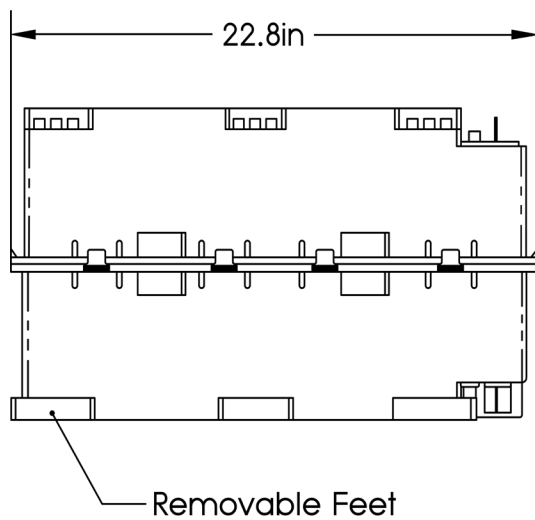



Battery Safety



LiFePO₄ batteries are inherently safe; however, like all batteries, energy storage devices, and electrical equipment, they pose potential safety and electrical hazards. Failure to follow these safety instructions could result in electrical shock, injury, or death, as well as damage to the battery, equipment, or property.

WARNING

Failure to follow these safety guidelines can result in property damage, personal injury, or worse. Please read the following material carefully before installation or use:

- Do **NOT** short battery terminal.
- Do **NOT** reverse polarity.
- Do **NOT** pierce the battery casing.
- Do **NOT** attempt to disassemble.
- Do **NOT** drop or mishandle.
- Do **NOT** immerse in water.
- Do **NOT** operate with loose connections.
- Do **NOT** operate the battery in series or in parallel with any other type of battery.
- Do **NOT** operate using cables that cannot accommodate the maximum current that can be delivered by the batteries

Please contact technical support to verify that you are using appropriate cables and contacts.

If the product is damaged upon arrival, please contact the manufacturer for product support.

DISCLAIMERS

- The buyer assumes responsibility for any damages resulting from the misuse of our products.
- Mishandling or misuse of our products will void the warranty.

INSTALLATION

- The battery should be installed as per national and local codes
- The battery should only be installed in locations approved by local building codes.
- Always store in a Type 3R enclosure when used in outdoor environments.
- Electrical and shock hazards can be minimized by covering the solar array and using insulated tools.
- Do not short the battery terminals.
- Do not install the battery if there are any signs of physical damage.
- Do not install the battery in a location that may be flooded.

OPERATION

- Use only approved battery chargers for charging the battery.
- Do not disassemble the battery.

EMERGENCY

- Disconnect the battery from the system.
- Wear a respirator, eye protection, and rubber gloves where appropriate.
- Use an ABC type dry chemical fire extinguisher.
- Dispose of as per local regulations.

DISPOSAL

- This product contains lithium-ion batteries and other recyclable materials.
- We strongly encourage customers to recycle unused or retired batteries.
- For guidance on proper recycling methods, please contact us directly.
- Ensure that unused or retired batteries are disposed of responsibly and in compliance with local laws and regulations.



Installation Guide

What Do I Need for Installation?

If your system is already set up and ready for the batteries, you will need a torque wrench capable of properly torquing the 5/16" finishing hardware.

- **Important:** Properly torque the hardware to 9 to 11 ft-lbs. Failure to meet this specification may result in system damage or failure.

Connecting Load Specified Cables to the Batteries

1. Identify Terminals:

- Positive (+): Red
- Negative (-): Black



Select Hardware:

- Choose the appropriate finishing hardware set.
- Ensure the bolt can fully seat into the nylok insert of the nut.
- If multiple lugs are used, longer bolts may be required for the bolt to fully seat into the nylok insert of the nut

3. Connect Cables:

- Attach the positive load specified cable lug to the positive terminal.
- Attach the negative load specified cable lug to the negative terminal.
- Follow the order shown in the diagram below for correct connection.

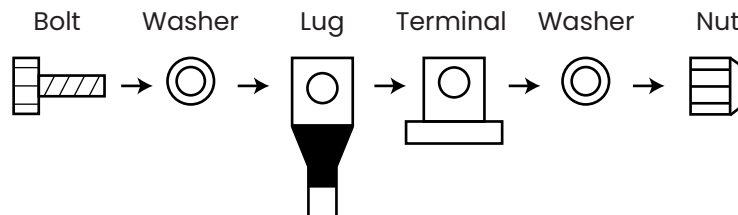

4. Secure Connections:

- Do NOT finger tighten.
- Use a torque wrench to tighten hardware to the specification of 9-11 ft-lbs.
- Inadequate tightening can result in severe damage and void the warranty.
- Reference the diagram below for a demonstration of proper and improper connections

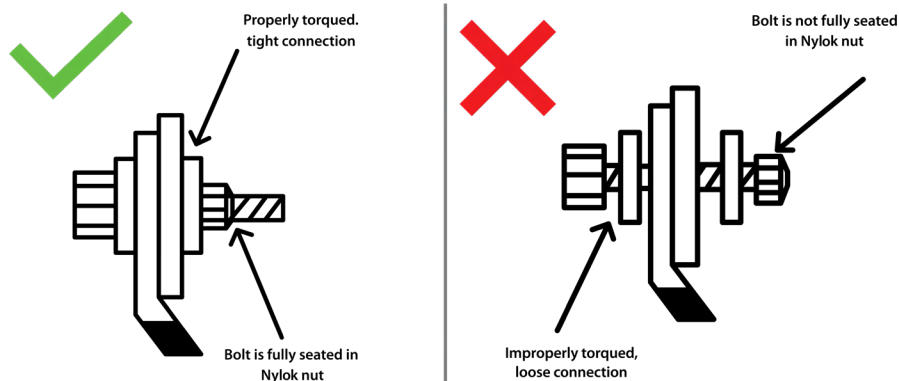



Properly Charging the Batteries

How to Properly Charge Your Battle Born Batteries

To ensure optimal performance and longevity, it's crucial to charge your Battle Born batteries correctly. Please verify that any charging component in your system (such as converters, inverter chargers, solar charge controllers, or DC-to-DC chargers) are capable of being programmed to the following specifications:

Charging Profile

Bulk/Absorption	14.2V - 14.6V
Absorption Time	60-90 minutes per battery (for parallel string)
Float	13.4V - 13.8V
Equalization	14.4V/ Disabled
Temperature Compensation	0/Disabled
Charge Rate	.5c

Operating Temperature Range

Battery Charge Temperature Range	32°F to 131°F (0°C to 55°C)
Battery Discharge Temperature Range	-4°F to 140°F (-20°C to 60°C)
Cell Charge Temperature	32°F to 131°F (0°C to 55°C)
Cell Discharge Temperature	-4°F to 140°F (-20°C to 60°C)

Note: Not all chargers support multi-stage charging. If your charger is not capable, ensure it can be programmed for the Bulk/Absorption voltage and that other features like equalization and temperature compensation are disabled. Please consult your charger's manual or the manufacturer for specific instructions.



Parallel Batteries Connection

Why Connect in Parallel?

Multiple BBGC3i batteries may be connected in parallel to increase the capacity and current of the system. When batteries are connected in parallel, the voltage of the system does not change, but the capacity and current limits are additive. For example, two BBGC3i batteries connected in parallel (shown in the diagrams below) create a 12V 200Ah bank that can deliver 200A continuously and 200A for 30 seconds.

How to Make a Parallel Connection

Note: All cables and connections MUST be able to accommodate the high currents that can be delivered by the battery. Appropriate fuses and circuit breakers are highly recommended to protect downstream components from current spikes and short circuits.

1. Identify the positive and negative terminals. These are labeled and color-coded **red for positive (+)**, **black for negative (-)**.
2. Determine the appropriate finishing hardware set you will use. Verify that your bolt can fully seat into the nylok insert of the nut. If multiple lugs are used, longer bolts may be required for the bolt to fully seat into the nylok insert of the nut.
3. Make the proper cable connections to the positive of the first battery. Please reference the diagram on page 14 below "Connect Cables" for the proper order of hardware.
4. When connecting to your battery terminals, **DO NOT** finger tighten. Use a torque wrench to torque your hardware to the specification of 9 to 11 ft-lbs. Failure to adequately secure connections can result in severe damage and will void your warranty.
5. Connect the other end of your positive cable to the positive terminal of the other battery you are connecting to. Repeat step 4.
6. Repeat steps 3-5 for the negative connections.
7. Repeat steps 3-6 for additional batteries in the system. An example of a finished connection can be found in the diagrams below.

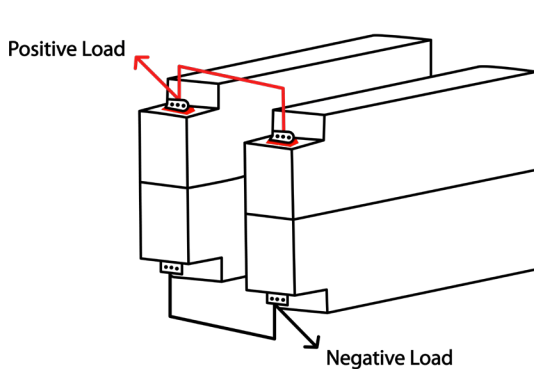

Two GC3i Batteries connected in Parallel to create a 12V 540Ah Battery Bank

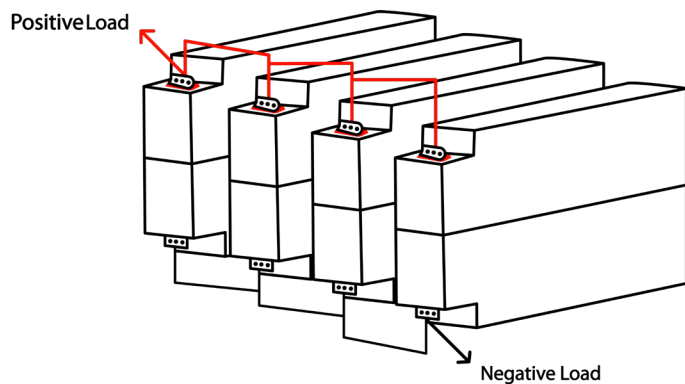

Four GC3i Batteries connected in Parallel to create a 12V 1,080Ah Battery Bank



Series Batteries Connection

Why Connect in Series?

When batteries are connected in series, current capacities remain the same, but the system voltage is additive. For example, two BBGC3i batteries connected in series form a 24V 100Ah bank (shown in the diagrams below) and should be charged using a bulk and absorption voltage of 28.8V, and a float voltage of 27.2V.

How to Make a Series Connection

Note: Battle Born GC2i batteries are capable of being connected in series up to 48V. DO NOT exceed a 48V setup or you will void the batteries' warranty.

1. Before making any connections, make sure to charge each battery up to 14.2V - 14.6V with a proper lithium charger. **ALL BATTERIES SHOULD BE AT THE SAME STATE OF CHARGE PRIOR TO CONNECTING**, otherwise you will encounter balance issues within your system. You can check your battery's state of charge with a multimeter.
2. Identify the positive and negative terminals. These are labeled and color-coded **red for positive (+)**, **black for negative (-)**.
3. Determine the appropriate finishing hardware set you will use. Verify that your bolt can fully seat into the nylok insert of the nut. If multiple lugs are used, longer bolts may be required for the bolt to fully seat into the nylok insert of the nut.
4. Make the proper cable connections to the negative of the first battery. Please reference the diagram on page 14 below "Connect Cables" for the proper order of hardware.
5. When connecting to your battery terminals, **DO NOT** finger tighten. Use a torque wrench to torque your hardware to the specification of 9 to 11 ft-lbs. Failure to adequately secure connections can result in severe damage and will void your warranty.
6. Connect the other end of your cable to the positive terminal of the other battery you are connecting to. Repeat step 4.
7. Repeat steps 3-6 for additional batteries, but **DO NOT** exceed 48V. An example of a correct series connection can be found in the diagrams below.

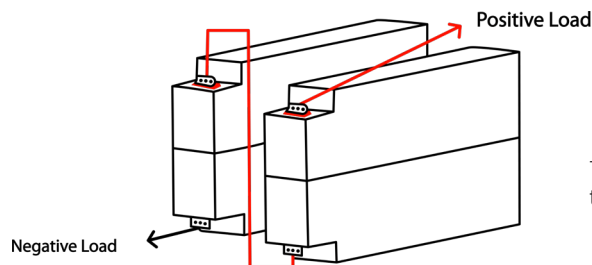

Two GC3i Batteries connected in series to create a 24V 270Ah Battery Bank

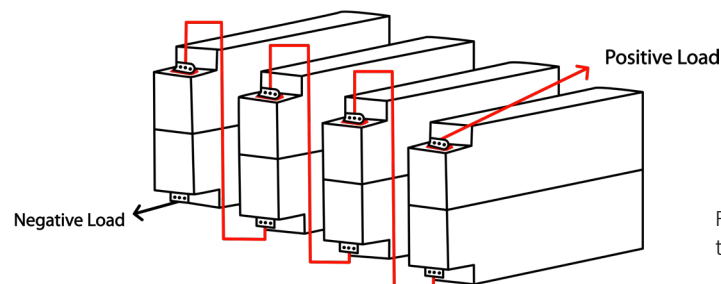

Four GC3i Batteries connected in series to create a 48V 270Ah Battery Bank



Battery Management System (BMS)

All Battle Born Batteries come equipped with a built-in Battery Management System (BMS) designed to safeguard the cells from various extreme conditions, thereby extending their lifespan and shielding your electrical system from potential damage.

BBGC3i | BBGC3iH BMS

- Max Continuous Current: 300 Amps
- Max Surge Current: 500 Amp surge for 30 seconds
- 1/2 second surge for loads over 500 Amps

High Voltage Disconnect (> 14.7V)

If an individual cell voltage exceeds a prescribed threshold during charging, the BMS will prevent a charge current from continuing. Discharge is always allowed under this condition. If the batteries have not been balanced for a long time, high voltage disconnect could occur at a lower voltage. The batteries will rebalance after several full charges.

Low-Voltage Disconnect (< 10.6V)

If an individual cell falls below a prescribed threshold during discharge, the BMS will prevent further discharge. Although the battery is in "low-voltage disconnect" mode, it will still allow a charging current.

Note: Many chargers must detect a voltage over 10V to send a charge to the battery. Please be aware that some chargers may not sense a battery in low-voltage disconnect and you may need to jump it with a 12V source to "wake up" the battery. You should jump your battery within 24hrs of entering low-voltage disconnect otherwise you risk damaging your battery and voiding the warranty.

High Temperature Charging and Discharging

The BMS will not allow a charging current if the battery's internal temperature exceeds 131°F (55°C).

The BMS will prevent discharging if the battery's internal temperature reaches 140°F (60°C) or higher.

Low Temperature Charging (< 25°F/-3.9°C)

The BMS will not allow a charging current under 32°F (0°C) but will continue to discharge down to -4°F (-20°C).

Note: The BBGC3i | BBGC3iH has an operating temperature range of -4°F (-20°C) to 131°F (55°C).

High Current Discharge Surges

The BMS will not allow a current that exceeds 500 (+/- 5%) Amps for more than 30s, or anything larger for 0.5s. After a high current disconnection, the battery will automatically reconnect after 5 seconds.

Short Current Discharge Surges

The Battery Management System (BMS) incorporates built-in short circuit protection. In the event of a short circuit, the BMS will automatically shut down the battery and remain in a disconnected state until the battery cables are removed.

To resolve this issue and re-establish battery functionality:

- Disconnect the battery cables.
- Use a voltmeter to measure the battery voltage.
- If the voltage reading exceeds 10V, reconnect the battery cables.
- If the voltage reading is below 10V, please contact our technical support team for further assistance.

Balancing of Cells

A passive balancing process is activated by the BMS at the top of each charge cycle when the battery voltage exceeds around 14.2V. This ensures that all the cells remain at the same state of charge, which helps pack longevity and performance.



Dragonfly IntelliGence: Smart Battery Technology

Overview of Dragonfly Intelligence Technology



Dragonfly Intelligence® is the proprietary communication system that enables seamless integration and advanced features in Battle Born® Smart LiFePO4 Batteries and accessories.

Communication Range

Bluetooth | Hub → 15 meters (~50ft) → User Mobile Device

The Battle Born Mobile App, when paired with the Battle Born Hub, offers seamless communication with your Battle Born Smart Batteries via Bluetooth. The app provides real-time monitoring of your battery system's performance, including charge levels, temperature, and health, with a comfortable Bluetooth range of up to **15 meters (~50ft)**.

Wireless Mesh Network | Batteries → 10 to 15 meters (~ 30 ft to 50 ft) → Hub

The Battle Born Mobile App, when paired with the Battle Born Hub, offers seamless communication with your Battle Born Smart Batteries via Bluetooth. The app provides real-time monitoring of your battery system's performance, including charge levels, temperature, and health, with a comfortable Bluetooth range of up to **15 meters (~50ft)**.

System Update Frequency

The Battle Born Smart Batteries provide data updates from the Battery Management System (BMS) every 5 seconds, delivering near-instantaneous insights into key performance metrics like state of charge (SOC), battery health (SOH), temperature, and voltage. This high-frequency data refresh rate ensures you have real-time visibility into your battery's status. Additionally, any issues reported by the BMS, such as over-temperature or overload conditions, are immediately relayed to the app, allowing for proactive monitoring and quick response to potential problems. This rapid data flow empowers you to keep your energy system running efficiently and reliably.

Power Draw

The Bluetooth Dongle integrated into your Battle Born Smart Batteries has a nominal power draw of approximately 10mA, ensuring minimal impact on your battery's overall performance. This low-energy consumption enables the Bluetooth connection to remain active for extended periods without significantly draining your battery, facilitating seamless real-time monitoring and communication. It's important to note that while there may be slight power draw increases during specific operations, such as initial configuration or firmware updates (peaking around 30mA and 50mA, respectively), these events are typically brief and have negligible impact on battery life. The power draw remains relatively consistent regardless of whether the battery is configured as a standalone unit or part of a larger system, with a maximum observed increase of approximately 0.5mA. **Make sure to account for this constant power draw when planning your battery storage to ensure optimal performance and longevity.**

Battle Born HUB

The Battle Born HUB is equipped with Dragonfly Intelligence technology and allows users to wirelessly receive signals from smart batteries, providing increased accessibility to new features and comprehensive system monitoring.



HUB Installation Guide

- A HUB is a necessary component for any Battle Born Smart Battery system that includes two or more batteries. It enables configuration, monitoring, and optimal performance of the entire battery bank system.
- To power the HUB, connect the included HUB Power Cable (12V/24V to 5V DC-DC Converter) directly to a true 12V or 24V power source.
- The network output protocols include Bluetooth, with additional protocols, such as RV-C to be added in future firmware updates.

Location

1. When installing the HUB, you have flexibility in its placement, as it can be located up to 15 meters away from your battery bank.

Connect the 5V Power Cable to the HUB:

2. Take the 5V side of the included HUB Power Cable.
3. Insert the 5V connector into the designated power input port on the HUB. Ensure it is securely plugged in, making sure the connection is firm and there is no loose contact.

Connect the 12V/24V Power Cable to the Power Source:

4. Now, take the 12V/24V side of the included HUB Power Cable.
5. Plug the 12V/24V connector into a reliable, true 12V or 24V power source. This could be your vehicle's electrical system, a dedicated 12V/24V battery, or another 12V/24V power supply.
6. Ensure that the power source is stable and capable of providing the correct voltage for the HUB to function properly. Make sure the 12V/24V connection is secure and properly insulated to avoid any short circuits.

Configuring Your System

7. On the home screen, select "Configure".
 - a. Alternatively, choose "Add a New System" at the bottom of the "My Systems" page.

Scanning Your HUB

8. Select Multi-Battery System, then scan the QR Code on your HUB
 - i. For the most seamless pairing, we recommend using the View Discoverable Devices feature. Simply select "Multi-Battery System" and choose your HUB from the list of available devices. Ensure your device is within Bluetooth range.
 - ii. If you prefer to use the QR code, you can scan the code on your HUB.

Configuration

9. Follow steps in multi- battery setup to set up your battery bank.

Identifying Your Smart Battery

To connect your Battle Born Smart Battery to the app, you'll need to commission it through the HUB. There are a couple ways you can identify the batteries before adding them into your system.

1. **Search Discoverable Devices:** Use the app to search for discoverable devices by serial number.
2. **Scan the QR Code:** If needed, locate the QR code etched onto the battery or the additional sticker in the box and scan it.

You can find the serial number below the QR code on the battery.

Battle Born Mobile App

The Battle Born Mobile app is an intuitive, user-friendly tool designed to monitor and manage your Battle Born Smart Batteries from the palm of your hand. Whether you're powering an off-grid cabin, an RV, or critical equipment in the field, this app gives you real-time insight into your battery system's performance. With the app, you can easily track important metrics like battery state of charge (soc), voltage, and temperature—ensuring your batteries are operating at peak efficiency. The app provides push notifications and alerts for any potential issues, such as abnormal temperature spikes or low charge levels, so you can take proactive action to protect your investment. Seamlessly integrate the app with your Battle Born Smart Batteries for complete control over your energy storage system—whether you're at home, on the road, or in remote locations.



App is Available on Apple Store
(Android version coming soon)

System Connectivity and Configuration

Commissioned and Connected:

- When your system is commissioned and you're actively connected to the HUB via Bluetooth, your system is exclusively accessible to you.
- Other users cannot see or connect to your HUB

Not Connected:

- If you're not actively connected to the HUB, other users within Bluetooth range may be able to see and potentially connect to it.

HUB Internal Storage and Memory:

- The system configuration is stored internally within the HUB.
- A HUB can only store a single system configuration at a time.

Smart Battery Setup Guide (Single Battery System)

Note: HUB is compatible with but not required for a Single Battery System.

When first configuring your system, a step by step video tutorial will prompt within the app.



Account Setup

1. Go to "My Account" to create a new account or log in to an existing one.

Configuring Your System

2. On the home screen, select "Configure".
 - a. Alternatively, choose "Add a New System" at the bottom of the "My Systems" page.

Scanning Your Battery

3. Select Single Battery System then scan the QR Code on your battery
 - a. If you have any issues scanning the QR code, you can select "View Discoverable Devices" and select your battery from the list. You must be in the bluetooth range of the device in order for it to appear on this screen.

Battery Naming

4. Before continuing, you have the option to edit the name of your battery by selecting "Edit Name"
5. Once finished, select "Continue".

Configuration

6. Select "Complete System Setup". This may take a few minutes.
7. Upon System Setup completion, you can then name your system.

Conclusion

8. Your System is now successfully configured. You can access and monitor it via the "My Systems" page.

Smart Battery Setup Guide (Multi-Battery System)

Note: HUB is required for all Multi Battery Systems.

When first configuring your system, a step by step video tutorial will prompt within the app.



Account Setup

1. Go to "My Account" to create a new account or log in to an existing one.

Configuring Your System

2. On the home screen, select "Configure".
 - a. Alternatively, choose "Add a New System" at the bottom of the "My Systems" page.

Scanning the Hub

3. Select Multi-Battery System then, scan the QR Code of the system's Dragonfly Intelligence HUB
 - i. If you have any issues scanning the QR code, you can select "View Discoverable Devices" and select your hub from the list. You must be in the bluetooth range of the device in order for it to appear on this screen.

System Specifications

4. Next, input the specifications of your system
 - i. Once finished, select "Continue".
 - a. System Voltage
 - b. The model of your batteries
 - c. And how many batteries you have in your system
 - d. A preview of your system will appear. Press "Continue"

Scanning Batteries

5. After completing this information, you'll need to scan each battery into your system. Please do this in the order in which they are or will be wired.
6. Scan the QR code of the first battery.
 - i. If unable to scan, use "View Discoverable Devices" to select the battery by serial number.
 - a. An optional QR code sticker is also included with your battery. You can keep this somewhere safe or adhere to somewhere more accessible for future use.
 - ii. Each battery will appear in a list below the scanning box as it is scanned in.
7. Scan the remaining batteries into your system.

Battery Naming

8. Before continuing, you have the option to edit the name of each battery by selecting "Edit Name"
9. Once finished, select "Continue".

Configuration

10. On the next page, drag and drop batteries into the system configuration, following the systems wiring order (especially important for series configurations).

Columns represent series groups, and each column is in parallel with all other columns.

GUIDE

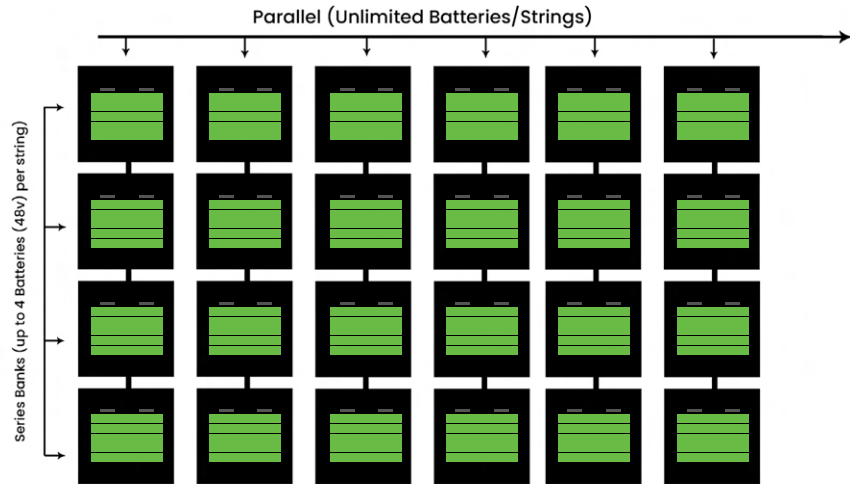
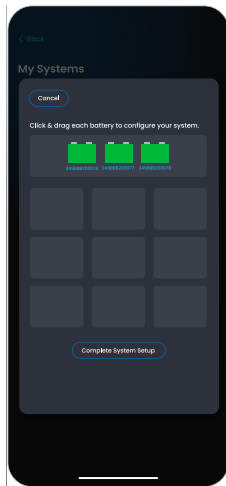

Example 12V System
(8x 12v Batteries Wired in Parallel)



Example 48V System
(8x 12v Batteries,
Wired in Series to 48V Series Parallel System)

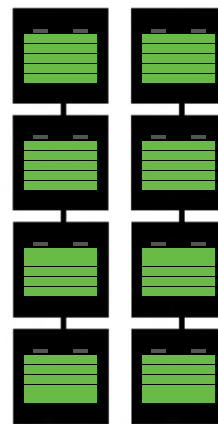

EXAMPLES

Example 24V System
(8x 12v Batteries, Wired in Series to 24V Series Parallel System)









11. Select "Complete System Setup". This may take a few minutes.
12. Upon System Setup completion, you can then name your system.

Conclusion

13. Your System is now successfully configured. You can access and monitor it via the "My Systems" page.

Battle Born Mobile App Overview

Status Legends

	No Errors or Warnings Present		No error or warning detected
	Warnings Present in System		Warning detected for this status item
	Errors Present in System		Error detected for this status item
			Battery status unknown due to a monitoring error

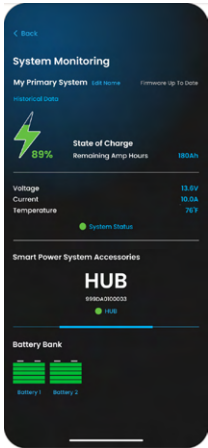

Systems Monitoring

State of Charge	Percentage of remaining capacity for entire system
Remaining Amp Hours	Remaining capacity of system
Voltage	Real time system voltage
Current	Real time load on system
Temperature	Average temperature across the entire system

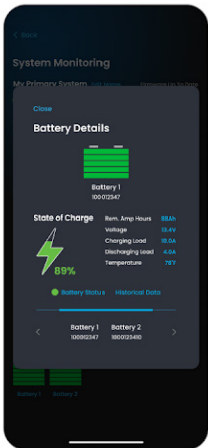

Battery Details

State of Charge	Percentage of remaining capacity for individual battery
Remaining Amp Hours	Remaining capacity of battery
Voltage	Real time battery voltage
Current	Real time load on individual battery
Temperature	Internal temperature of battery

Setting Custom Alerts in the Mobile App

Within the app, you can set up custom alerts to receive notifications in the event of any issues with your battery system. These alerts help you stay informed about the health and performance of your system, ensuring you can take action promptly if something goes wrong. To configure this feature, follow the steps outlined below:

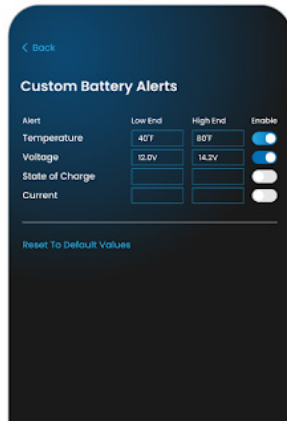

1. Open the App

- Launch the app on your device and log in to your account if necessary.

2. Navigate to My Systems > System Status

- From the homepage, go to "My Systems" and select your system. This will take you to the System Monitoring Page.
- Click on "System Status" to view an overview of your system's status.

3. Prepare for the Update

- At the bottom of the System Status page, click on "Customize System Alerts."

4. Choose the Alerts You Wish to Customize

- Select the types of issues you'd like to be alerted about, such as low battery voltage, state of charge, temperature fluctuations, or current.

5. Set Alert Thresholds

- For each alert type, set the specific thresholds that will trigger notifications, both for high and low limits. For example, you can set alerts for when battery voltage drops below a certain level or when temperature exceeds a safe range

6. Save and Activate the Alerts

- Once you've configured your alerts, click the "Enable" button to activate them. The app will then monitor your battery system according to your settings and send push notifications if any of the conditions are met.

By setting up these custom alerts, you ensure proactive monitoring of your battery system, helping to prevent potential issues and maintain optimal performance.

Firmware Updates

Firmware updates are crucial for maintaining your battery system's performance, security, and functionality. They introduce new features, improve system performance, fix bugs, and ensure compatibility with other components. Keeping your firmware up to date ensures you benefit from the latest enhancements and configuration options.

Follow these steps to update your system's firmware:

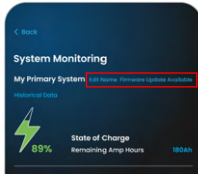

1. Check for Available Updates

- Open the app and navigate to “My System.” If an update is available, you’ll see a notification saying “Firmware Update Available.”

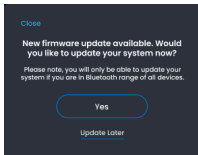

2. Review Update Details

- If an update is available, review the details, which may include new features, bug fixes, or optimizations. If you’re comfortable with the changes, click “Yes” to begin the update process.

3. Prepare for the Update

- Ensure your battery system is properly connected and the power source is stable. It's best to perform the update when the system is not in use to avoid interruptions. Also, make sure your device (phone or tablet) has sufficient battery or is plugged in.

4. Initiate the Update

- Click the “Pair All” button on your screen. The system will begin downloading the necessary files and start the update process. This may take a few minutes, depending on the update size.

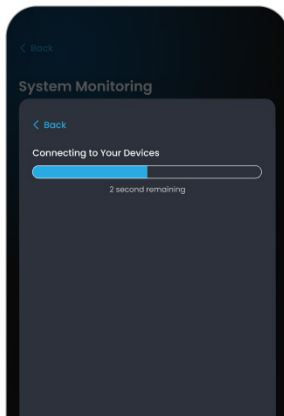

5. Set Alert Thresholds

- For each alert type, set the specific thresholds that will trigger notifications, both for high and low limits. For example, you can set alerts for when battery voltage drops below a certain level or when temperature exceeds a safe range.

6. Confirm the Update

- Once the update is complete, return to the “My System” page. If the update was successful, you’ll see “Firmware Up to Date” in the top right corner of your screen.

Best Practices: What to Avoid

- **Do NOT** walk away from your smart batteries or components with the mobile device performing or configuring the updates while they are in progress.
- **Do NOT** attempt to configure the same system across multiple accounts or use the same components in multiple configurations.

Troubleshooting

Issues Connecting to Components

- Ensure you are physically close to the components.
- Verify that the components are powered on and Bluetooth is enabled.
- Restart your bluetooth connection.
- Restart your mobile device.

Issues Monitoring After Configuration

- Allow at least 2 minutes for the HUB to fully connect to the batteries after configuration.
- Ensure the HUB is within a reasonable distance of the batteries and free from interference.
- If the issue persists, try the following steps in order:
 - Power cycle the HUB.
 - Close and reopen the app.
 - View the system in monitoring mode and wait 30 seconds for a potential firmware update. If available, proceed with the update.
- If the issue STILL persists, delete the system and reconfigure it.
- If the problem continues, contact support for further assistance.

Issues During Configuration

- Ensure you are within a reasonable distance of all components.
- Close and reopen the app.

Issues Signing In:

- Contact support for assistance with account recovery.



Additional System Considerations

Cable Sizing for System Installation

Proper cable sizing is crucial for optimal system performance and safety. Several factors influence cable selection. Use this chart (the diagram shown below) as a general reference for selecting appropriate cable gauges based on the current and distance in your system.

1. Load Size: Determine the power consumption of the devices you intend to power with the battery bank.
2. Cable Length: Consider the distance between the battery and the load.
3. Voltage Drop: Calculate voltage drop to ensure adequate power delivery.

Important Considerations:

- Amperage Capacity: Cables have limitations on the amount of current they can safely carry.
- Cable Specifications: Verify the specific amperage rating of your chosen cable.
- Power Draw: Ensure that the cable's capacity aligns with the combined power draw of your connected devices.

By carefully considering these factors, you can select appropriate cables to prevent potential failures and damage to your system.

CURRENT (A)	0-5	16 AWG	16 AWG	16 AWG	16 AWG	14 AWG	12 AWG	12 AWG
	5-10	16 AWG	16 AWG	14 AWG	12 AWG	10 AWG	10 AWG	10 AWG
	10-15	14 AWG	14 AWG	12 AWG	10 AWG	10 AWG	8 AWG	8 AWG
	15-20	14 AWG	12 AWG	12 AWG	10 AWG	8 AWG	6 AWG	6 AWG
	20-25	12 AWG	10 AWG	10 AWG	8 AWG	6 AWG	6 AWG	6 AWG
	25-30	10 AWG	10 AWG	10 AWG	8 AWG	6 AWG	6 AWG	4 AWG
	30-40	8 AWG	8 AWG	8 AWG	6 AWG	6 AWG	4 AWG	4 AWG
	40-50	8 AWG	8 AWG	6 AWG	6 AWG	4 AWG	4 AWG	2 AWG
	50-60	6 AWG	6 AWG	6 AWG	4 AWG	4 AWG	2 AWG	2 AWG
	60-70	6 AWG	6 AWG	4 AWG	4 AWG	2 AWG	2 AWG	1/0 AWG
	70-80	4 AWG	4 AWG	4 AWG	4 AWG	2 AWG	2 AWG	1/0 AWG
	80-90	4 AWG	4 AWG	4 AWG	2 AWG	2 AWG	1/0 AWG	1/0 AWG
	90-100	2 AWG	2 AWG	2 AWG	2 AWG	2 AWG	1/0 AWG	1/0 AWG
	100-120	2 AWG	2 AWG	2 AWG	2 AWG	1/0 AWG	1/0 AWG	2/0 AWG
	120-150	1/0 AWG	1/0 AWG	1/0 AWG	1/0 AWG	1/0 AWG	2/0 AWG	4/0 AWG
	150-200	2/0 AWG	2/0 AWG	2/0 AWG	2/0 AWG	2/0 AWG	4/0 AWG	4/0 AWG
	0-4	4-7	7-10	10-15	15-20	20-25	25-30	
LENGTH IN FEET								

Recommended Cable Gauge Based on Current and Distance.

How to Incorporate Fuses into System Install

ANL fuses are designed to protect your system by melting and separating in case of excessive current. These fuses are essential components for protecting against a catastrophic event and should be placed between your Battle Born Battle Born Batteries and the inverter/load.

Voltage vs. Capacity (Single Battery)

Battle Born LiFePO4 batteries, exhibit a characteristic voltage drop during discharge.

The provided voltage vs. capacity charts illustrate the relationship between battery voltage and remaining capacity at different discharge rates. The curves on the chart represent the voltage profile for various discharge currents. It's evident that higher discharge rates result in a steeper voltage decline.

14.4V	100%
13.6V	100%
13.4V	99%
13.3V	90%
13.2V	70%
13.1V	40%
13.0V	30%
12.9V	20%
12.8V	17%
12.5V	14%
12.0V	9%
10.0V	0%

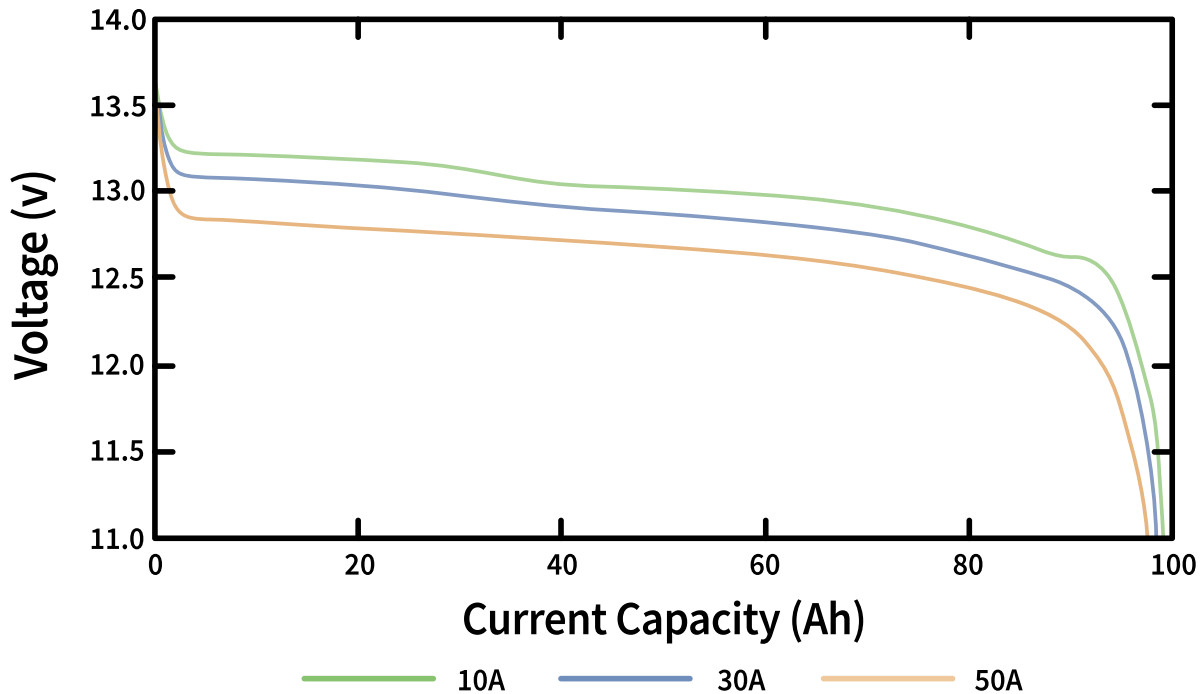



**Storage, Maintenance,
Recycling & Disposal**

Battery Storage Recommendations

- **Charge Fully:** Bring batteries to 100% state of charge.
- **Disconnect Load:** Remove the negative cable from one battery.
- **Monitor Capacity:** Batteries lose 2-3% capacity per month
 - **Subject to increasing if stored in extreme environmental conditions*

Battery Maintenance

Battle Born Batteries require minimal maintenance, but the following recommendations will help ensure your system remains in optimal condition:

- **For Batteries in Series:** If your batteries are not charged by a multi-bank charger, it is recommended to fully charge each battery individually once per year, especially with frequent use. This process internally balances the batteries, helping them achieve their expected lifespan and deliver full power with each use.
- **For Batteries in Parallel:** Individual charging is unnecessary. Simply ensure the batteries are charged to 14.2V – 14.6V regularly to maintain internal balance. The built-in Battery Management System (BMS) includes a passive balancing feature that will automatically handle this process for you.

Note: A Current Surge Limiter (CSL) is required for use with inverters rated at 3500W or higher.

How to Properly Recycle and Dispose of Batteries

Dragonfly Energy, maker of Battle Born Batteries, is committed to providing long-lasting green energy solutions that support your adventures for years. In addition to building durable, reliable batteries, we offer industry-leading customer support to help you maximize their lifespan. When your batteries do reach the end of their life, it's important to recycle them responsibly.

Here are a few steps to follow:

- **Preparation:** Before removing the batteries, ensure all loads are disconnected from your system. Once the batteries are removed, cover the terminals with electrical tape for safety. This is also a good opportunity to inspect cable runs and lugs for any wear or damage.
- **Locate a Recycling Center:** Visit www.earth911.com or www.call2recycle.org/locator to find a drop-off location near you. Be sure to call ahead to confirm the location is still accepting materials.
- **Need Help?** If you encounter any difficulties finding a drop-off location, don't hesitate to contact us. We're happy to assist you in identifying a suitable recycling center.

Recycling your batteries properly helps protect the environment and supports our shared mission of sustainability.



Warranty, Returns & Shipping

Limited Warranty

Please find Limited Warranty information online at www.battlebornbatteries.com/limited-warranty/ or via phone at (855) 292-2831.

Return Policy

You have 30 calendar days to return an item from the invoice date. To be eligible for a return, your item must be in the same condition that you received it in. You must have the receipt or proof of purchase. If an item is new, unused, and in the original packaging, we are happy to accept a return up to 30 days from the original invoice date with no restocking fee. The item must be returned with its original packaging. Original packaging must be in the same condition as it was received, otherwise you may be responsible for a restocking fee. If the item has been installed, used, or no longer has the original packaging, we will assess a restocking fee that will be shared when the return merchandise authorization (RMA) is issued. Items 60 days past the original invoice will be reviewed at Battle Born's discretion.

Returns will not be accepted without an RMA number, which can be obtained by filling out the return form at <https://battlebornbatteries.com/returns/>.

To avoid being charged restocking fees, review the full return/refund policy at www.battlebornbatteries.com/terms-conditions/#returns.

Refund Policy

You have 30 calendar days to return an item from the invoice date. Once we receive your item, we will inspect it and notify you that we have received your returned item. We will immediately notify you of the status of your refund after inspecting the item. If your return is approved, we will initiate a refund to your credit card (or original method of payment). You will receive the credit within a certain amount of days, depending on your card issuer's policies. No refund is guaranteed after the initial 30 days has passed or if the item has been used.

Shipping

You will be responsible for paying for your own shipping costs for returning your item. If you are returning prior to 30 days from the original ship date, you may be eligible for a free return. In order to be eligible for free shipping, you MUST have the original packing in which the order was shipped, including boxes, foam, wrapping, and pallets if necessary. Not all items will be eligible for free return shipping. Shipping costs are nonrefundable. If you receive a refund, the cost of return shipping may be deducted from your refund.

If you have any questions, please contact us by calling 855-292-2831 or email us at info@battlebornbatteries.com.

BATTLE BORN®

Unstoppable Power Solutions

Notice: Product improvements and enhancements are continuous; therefore, the specifications and information contained in this document may change without notice. Dragonfly Energy Corp. shall not be liable for errors contained herein or for incidental or consequential damages in connection with the furnishing, performance, or use of this material. No part of this document may be photocopied, reproduced, or translated to another language without the prior written consent of Dragonfly Energy Corp.

Copyright © 2024, Dragonfly Energy Corp., all rights reserved. Battle Born Batteries® and Battle Born® are registered trademarks of Dragonfly Energy Corp. All other trademarks, trade names, service marks, and logos referenced herein belong to their respective owners.