

# ProStar MPPT™

Solar Charging System Controller

Installation, Operation and Maintenance Manual



## MODELS

PS-MPPT-25  
PS-MPPT-25M  
PS-MPPT-40  
PS-MPPT-40M



# DIMENSIONS [inches (centimeters)]

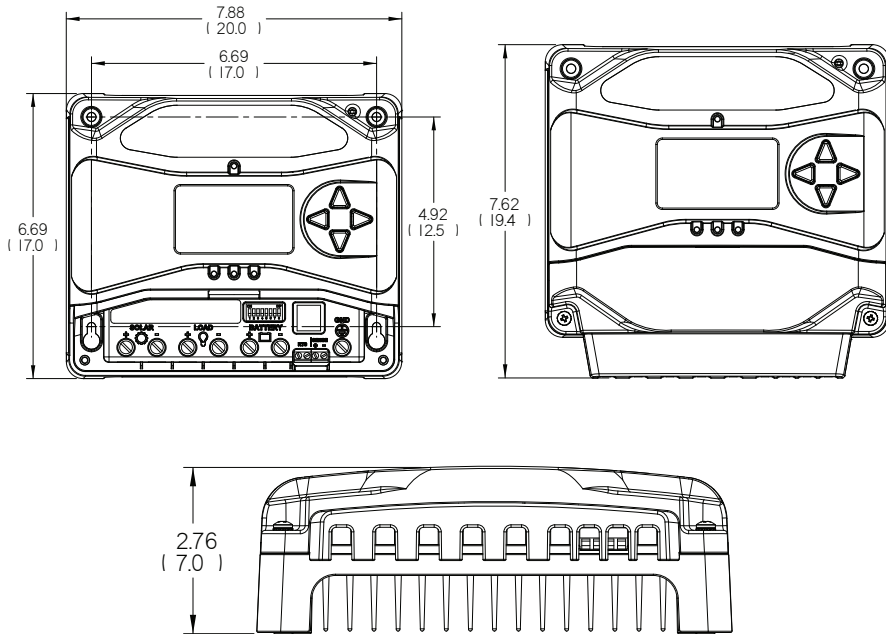

## SPECIFICATION SUMMARY

	PS-MPPT-25	PS-MPPT-40
Nominal Battery Voltage	12/24V	12/24V
Max. PV Open-Circuit Voltage*	120V	120V
Nominal Max. Input Power**	350 / 700W	560 / 1120W
Max. Battery Charging Current	25A	40A
Rated Load Current	25A	30A

\*Array voltage should never exceed this limit

\*\*These power levels refer to the maximum wattage the PS-MPPT can process. Higher power arrays can be used without damaging the controller.

# TABLE OF CONTENTS

- 1.0 Important Safety Instructions..... 1**
- 2.0 General Information.... 10**
  - 2.1 Overview..... 10
  - 2.2 Regulatory Information..... 11
  - 2.3 Versions and Ratings..... 13
  - 2.4 Features..... 14
  - 2.5 Optional Accessories..... 16
- 3.0 Installation..... 18**
  - 3.1 General Installation Notes..... 18
  - 3.2 Configuration..... 21
  - 3.3 Mounting..... 23
  - 3.4 Wiring..... 24
    - 3.4.1. Wire Sizing..... 25
    - 3.4.2 Required Overcurrent Protection Devices..... 26
    - 3.4.3 Wiring Connections..... 30
- 4.0 Operation..... 41**
  - 4.1 TrakStar MPPT Technology..... 41
  - 4.2 Battery Charging Information..... 43
  - 4.3 Load Control Information..... 53
  - 4.4 LED Indications..... 55
    - 4.4.1 Power-up..... 55
    - 4.4.2 Status LED..... 55
    - 4.4.3 State-of-charge LEDs..... 56
  - 4.5 Push-button Use in Non-Metered Version..... 56
  - 4.6 Alarms..... 57
  - 4.7 Custom Settings..... 59
    - 4.7.1 Programming with Meter Display..... 59
    - 4.7.2 Programming in MSView..... 60
    - 4.7.3 Meter Display Operation..... 60

## 1.0 IMPORTANT SAFETY INSTRUCTIONS

4.7.3.1	Directional Key Use and Operation / Navigating the Meter Map.....	60
4.7.3.2	Adjusting the Meter Display.....	61
4.7.4	Using the Meter Display to Program Charging Set-points, Load Control, Communications, and Advanced Settings.....	61
4.7.5	Lighting Control / Programming Overview.....	61
4.7.6	Lighting Programming Using Meter Display.....	62
4.7.7	Low Temperature Foldback.....	62
4.8	Inspection and Maintenance.....	63
<b>5.0</b>	<b>Troubleshooting.....</b>	<b>65</b>
5.1	LED Fault Indications.....	65
5.2	Battery Charging and Performance Issues.....	70
<b>6.0</b>	<b>Warranty and Policies.....</b>	<b>71</b>
<b>7.0</b>	<b>Technical Specifications.....</b>	<b>74</b>
<b>Appendix A - Efficiency.....</b>		<b>77</b>
<b>Appendix B - De-rating Graphs.....</b>		<b>79</b>
<b>Appendix C - Wire Sizing Charts.....</b>		<b>81</b>

## CERTIFICATION ADDENDUM TO OPERATOR'S MANUAL

### SAVE THESE INSTRUCTIONS.

This manual contains important safety, installation, operating and maintenance instructions for the ProStar MPPT solar controller.

The following symbols are used throughout this manual to indicate potentially dangerous conditions or mark important safety instructions:



**WARNING:** Indicates a potentially dangerous condition. Use extreme caution when performing this task.



**CAUTION:** Indicates a critical procedure for safe and proper operation of the controller.



**NOTE:** Indicates a procedure or function that is important to the safe and proper operation of the controller.

### CONSIGNES IMPORTANTES DE SÉCURITÉ CONSERVEZ CES INSTRUCTIONS:

Ce manuel contient des instructions importantes de sécurité, d'installations et d'utilisation du contrôleur solaire ProStar MPPT.

Les symboles suivants sont utilisés dans ce manuel pour indiquer des conditions potentiellement dangereuses ou des consignes importantes de sécurité.



**AVERTISSEMENT:** Indique une condition potentiellement dangereuse. Faites preuve d'une prudence extrême lors de la réalisation de cette tâche.



**PRUDENCE:** Indique une procédure critique pour l'utilisation sûre et correcte du contrôleur.



**REMARQUE:** Indique une procédure ou fonction importante pour l'utilisation sûre et correcte du contrôleur.

## Safety Information

- Read all of the instructions and cautions in the manual before beginning installation.
- There are no user serviceable parts inside the ProStar MPPT. Do not disassemble or attempt to repair the controller.



**WARNING:** Risk Of Electrical Shock.

**NO POWER OR ACCESSORY TERMINALS ARE ELECTRICALLY ISOLATED FROM DC INPUT, AND MAY BE ENERGIZED WITH HAZARDOUS SOLAR VOLTAGE. UNDER CERTAIN FAULT CONDITIONS, BATTERY COULD BECOME OVER-CHARGED. TEST BETWEEN ALL TERMINALS AND GROUND BEFORE TOUCHING.**



**WARNING:** THE COMMUNICATIONS PORT IS CONSIDERED TO BE DVC B. AN EXTERNAL

ISOLATOR IS REQUIRED IF IT IS TO BE CONNECTED TO A DVC A CIRCUIT.

- External solar and battery disconnects are required.
- Disconnect all sources of power to the controller before installing or adjusting the ProStar MPPT.
- There are no fuses or disconnects inside the ProStar MPPT. Do not attempt to repair.

## Informations de Sécurité

- Lisez toutes les instructions et les avertissements figurant dans le manuel avant de commencer l'installation.
- Le ProStar MPPT ne contient aucune pièce réparable par l'utilisateur. Ne démontez pas ni ne tentez de réparer le contrôleur.



**AVERTISSEMENT:** Risque De Choc Électrique.

**NON ALIMENTATION OU AUX BORNES D'ACCESSOIRES SONT ISOLÉS ÉLECTRIQUEMENT DE L'ENTRÉE DE C.C ET DOIT ÊTRE ALIMENTÉS À UNE TENSION DANGEREUSE SOLAIRE. SOUS CERTAINES CONDITIONS DE DÉFAILLANCE, LA BATTERIE POURRAIT DEVENIR TROP CHARGÉE. TEST ENTRE TOUTES LES BORNES ET LA MASSE AVANT DE TOUCHER.**



**AVERTISSEMENT:** LE PORT DE COMMUNICATION EST CONSIDÉRÉE COMME DVC B. UN ISOLATEUR EXTERNE N'EST NÉCESSAIRE SI C'EST D'ÊTRE CONNECTÉ À UN DVC UN CIRCUIT.

- External solaire et la batterie se déconnecte sont nécessaires.
- Déconnectez toutes les sources d'alimentation du contrôleur avant d'installer ou de régler le ProStar MPPT.
- Le ProStar MPPT ne contient aucun fusible ou interrupteur. Ne tentez pas de réparer.
- Installez des fusibles/ coupe-circuits externes selon le besoin.

## Installation Safety Precautions



**WARNING:** This unit is not provided with a GFDI device. This charge controller must be used with an external GFDI device as required by the Article 690 of the National Electrical Code for the installation location.

- Throughout this manual NEC guidance has been provided in order to meet general safety requirements and to inform of best installation practices. It is the installer's responsibility to ensure that the installation complies with all local safety and code requirements.
- Mount the ProStar MPPT indoors. Prevent exposure to the elements and do not allow water to enter the controller.
- Install the ProStar MPPT in a location that prevents casual contact. The ProStar MPPT heatsink can become very hot during operation.
- Use insulated tools when working with batteries.
- Avoid wearing jewelry during installation.
- The battery bank must be comprised of batteries of same type, make, and age.
- UL/IEC 62109 certified for use in negative ground or floating systems only.

- Do not smoke near the battery bank.
- Power connections must remain tight to avoid excessive heating from a loose connection.
- Use properly sized conductors and circuit interrupters.
- The grounding terminal is located in the case, and is identified by the symbol below:

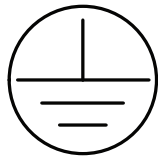

Ground Symbol

- This charge controller is to be connected to DC circuits only. These DC connections are identified by the symbol below:



Direct Current Symbol

The ProStar MPPT controller must be installed by a qualified technician in accordance with the electrical regulations of the country of installation.

A means of disconnecting all power supply poles must be provided. These disconnects must be incorporated in the fixed wiring.

The ProStar MPPT negative power terminals are common, and must be grounded as instructions, local codes, and regulations require.

A permanent, reliable earth ground must be established with connection to the ProStar MPPT ground terminal.

The grounding conductor must be secured against any accidental detachment.

## Précautions de Sécurité D'installation



**AVERTISSEMENT:** *L'appareil n'est pas fourni avec un dispositif GFDI. Ce contrôleur de charge doit être utilisé avec un dispositif GFDI externe tel que requis par l'Article 690 du Code électrique national de l'emplacement de l'installation.*

- Tout au long de ce manuel, des conseils NEC ont été fournis afin de répondre aux exigences générales de sécurité et d'informer sur les meilleures pratiques d'installation. Il est de la responsabilité de l'installateur de s'assurer que l'installation est conforme à toutes les exigences de sécurité et de code locales.
- Montez le ProStar MPPT à l'intérieur. Empêchez l'exposition aux éléments et la pénétration d'eau dans le contrôleur.
- Installez le MPPT ProStar dans un endroit qui empêche le contact occasionnel. Le dissipateur de chaleur ProStar MPPT peut devenir très chaud pendant le fonctionnement.
- Utilisez des outils isolés pour travailler avec les batteries.
- Évitez le port de bijoux pendant l'installation.
- Le groupe de batteries doit être constitué de batteries du même type, fabricant et âge.
- UL/IEC 62109 certifié pour utilisation au négatif à la masse ou les systèmes flottants seulement.
- Ne fumez pas à proximité du groupe de batteries.
- Les connexions d'alimentation doivent rester serrées pour éviter une surchauffe excessive d'une connexion desserrée.
- Utilisez des conducteurs et des coupe-circuits de dimensions adaptées.

- La borne de mise à la terre se trouve dans l'affaire et est identifié par le symbole ci-dessous :

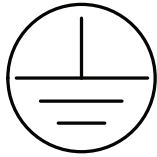

- Ce contrôleur de charge ne doit être connecté qu'à des circuits en courant continu. Ces connexions CC sont identifiées par le symbole ci-dessous:



Le régulateur MPPT ProStar doit être installé par un technicien qualifié conformément aux règlements du pays d'installation électriques.

Un moyen de déconnexion de tous les poteaux d'alimentation doit être fourni. Ceux-ci se déconnecte doit être intégrée dans le câblage fixe.

Une mise à la terre permanent et fiable s'impose avec raccordement à la borne ProStar MPPT.

Les bornes de puissance négative ProStar MPPT sont communs et doivent être mise à la terre comme les directives, les codes locaux, et les règlements exigent.

Le conducteur de terre doit être protégée contre tout détachement accidentel.

## Battery Safety



**WARNING:** A battery can present a risk of electrical shock or burn from large amounts of short-circuit current, fire, or explosion from vented gases. Observe proper precautions.



**AVERTISSEMENT:** Une batterie peut présenter a ris que de choc électrique ou de brûlure de grandes quantités de court-circuit curlouer, incendie ou explosion de ventilé gaz. Observer précautions appropriées.



**WARNING: Risk of Explosion.**

Proper disposal of batteries is required. Do not dispose of batteries in fire. Refer to local regulations or codes for requirements.

**AVERTISSEMENT: Risque d'Explosion.**



Au rebut des piles est nécessaire. Ne pas jeter les piles dans le feu. Se référer aux réglementations locales ou des codes pour les exigences.



**CAUTION:** When replacing batteries, use properly specified number, sizes, types, and ratings based on application and system design.



**PRUDENCE:** Lorsque le remplacement des piles, utilisez correctement nombre spécifié, tailles, types et les évaluations basées sur conception de système et d'application.



**CAUTION:** Do not open or mutilate batteries. Released electrolyte is harmful to skin, and may be toxic.



**PRUDENCE:** Ne pas ouvrir ou mutiler les piles. L'électrolyte est nocif pour la peau et peut être toxique.

- Servicing of batteries should be performed, or supervised, by personnel knowledgeable about batteries, and the proper safety precautions.
- Be very careful when working with large lead-acid batteries. Wear eye protection and have fresh water available in case there is contact with the battery acid.

- Remove watches, rings, jewelry and other metal objects before working with batteries.
- Wear rubber gloves and boots
- Use tools with insulated handles and avoid placing tools or metal objects on top of batteries.
- Disconnect charging source prior to connecting or disconnecting battery terminals.
- Determine if battery is inadvertently grounded. If so, remove the source of contact with ground. Contact with any part of a grounded battery can result in electrical shock. The likelihood of such a shock can be reduced if battery grounds are removed during installation and maintenance (applicable to equipment and remote battery supplies not having a grounded supply circuit).
- Carefully read the battery manufacturer's instructions before installing / connecting to, or removing batteries from, the ProStar MPPT.
- Be very careful not to short circuit the cables connected to the battery.
- Have someone nearby to assist in case of an accident.
- Explosive battery gases can be present during charging. Be certain there is enough ventilation to release the gases.
- Never smoke in the battery area.
- If battery acid comes into contact with the skin, wash with soap and water. If the acid contacts the eye, flood with fresh water and get medical attention.
- Be sure the battery electrolyte level is correct before starting charging. Do not attempt to charge a frozen battery.
- Recycle the battery when it is replaced.
- Entretien des batteries devrait être effectué ou supervisé, par un personnel bien informé sur les piles et les précautions de sécurité appropriées.
- Soyez très prudent quand vous travaillez avec des grandes batteries au plomb. Portez des lunettes de protection et ayez de l'eau fraîche à disposition en cas de contact avec l'électrolyte.

- Enlevez les montres, bagues, bijoux et autres objets métalliques avant de travailler avec des piles.
- Porter des bottes et des gants de caoutchouc
- Utiliser des outils avec poignées isolantes et évitez de placer des outils ou des objets métalliques sur le dessus de batteries.
- Débrancher la source de charge avant de brancher ou dis-reliant les bornes de la batterie.
- Utilisez des outils isolés et évitez de placer des objets métalliques dans la zone de travail.
- Déterminer si batterie repose par inadvertance. Dans l'affirmative, supprimer la source du contact avec le sol. Contact avec n'importe quelle partie d'une batterie mise à la terre peut entraîner un choc électrique. La probabilité d'un tel choc peut être réduite si des motifs de batterie sont supprimés pendant l'installation et maintenance (applicable à l'équipement et les fournitures de pile de la télécommande n'ayant pas un circuit d'alimentation mise à la terre).
- Lisez attentivement les instructions du fabricant de la batterie avant d'installer / connexion à ou retrait des batteries du ProStar MPPT.
- Veillez à ne pas court-circuiter les câbles connectés à la batterie.
- Ayez une personne à proximité qui puisse aider en cas d'accident.
- Des gaz explosifs de batterie peuvent être présents pendant la charge. Assurez-vous qu'une ventilation suffisante évacue les gaz.
- Ne fumez jamais dans la zone des batteries
- En cas de contact de l'électrolyte avec la peau, lavez avec du savon et de l'eau. En cas de contact de l'électrolyte avec les yeux, rincez abondamment avec de l'eau fraîche et consultez un médecin.
- Assurez-vous que le niveau d'électrolyte de la batterie est correct avant de commencer la charge. Ne tentez pas de charger une batterie gelée.
- Recyclez la batterie quand elle est remplacée.

### 2.1 Overview

Thank you for choosing the ProStar MPPT charge controller with TrakStar™ MPPT Technology. The ProStar MPPT is an advanced maximum power point tracking solar battery charger. The controller features a smart tracking algorithm that finds and maintains operation at the power source's peak power point, maximizing energy harvest.

The ProStar MPPT battery charging process has been optimized for long battery life and improved system performance. Self-diagnostics and electronic error protections prevent damage when installation mistakes or system faults occur. The controller also features eight (8) adjustable settings switches, several communication ports, and terminals for remote battery temperature and voltage measurement.

Please take the time to read this operator's manual to become familiar the many benefits the ProStar MPPT can provide for your PV systems, for example:

- Rated for 12 or 24 volt systems, and 25 or 40 amps of charging current
- Fully protected with automatic and manual recovery
- Seven standard charging programs selectable with DIP switches
- Continuous self-testing with fault notification
- LED indications and push-button or meter key functions
- Power terminals sized for #14-2 AWG (2.5-35mm<sup>2</sup>) wire - compliant when used with the optional Morningstar Wire Box. With standard terminal cover, maximum wire size is #6 AWG (16mm<sup>2</sup>) wire.
- Includes battery voltage sense terminals
- Digital meter display options
- Optional remote battery temperature sensor
- 5-year warranty (see Section 6.0)

### 2.2 Regulatory Information



**NOTE:** This section contains important information for safety and regulatory requirements.

#### FCC requirements:

This device complies with Part 15 of the FCC rules. Operation is subject to the following two conditions:

(1) This device may not cause harmful interference, and,

(2) this device must accept any interference received, including interference that may cause undesired operation.

Changes or modifications not expressly approved by Morningstar for compliance could void the user's authority to operate the equipment.



**NOTE:** This equipment has been tested and found to comply with the limits for a Class B digital device, pursuant to Part 15 of the FCC rules. These limits are designed to provide reasonable protection against harmful interference in a residential installation. This equipment generates, uses, and can radiate radio frequency energy and, if not installed and used in accordance with the instruction manual, may cause harmful interference to radio communication. However, there is no guarantee that interference will not occur in a particular installation.

If this equipment does cause harmful interference to radio or television reception, which can be determined by turning the equipment on and off, the user is encouraged to try to correct the interference by one or more of the following measures:



- Re-orient or relocate the receiving antenna.
- Increase the separation between the equipment and receiver.
- Connect the equipment into an outlet on a circuit different from that to which the receiver is connected.
- Consult the dealer, or an experienced radio/TV technician for help.

This Class B digital apparatus complies with Canadian ICES-003.

Cet appareil numérique de la classe B est conforme à la norme NMB-003 du Canada.

## 2.3 Versions and Ratings

---

### **PS-MPPT-25**

- Rated for maximum 25 amps continuous current (battery or load)
- Designed for 12 or 24 VDC systems

### **PS-MPPT-25M**

- Includes metering display
- Rated for maximum 25 amps continuous current (battery or load)
- Designed for 12 or 24 VDC systems

### **PS-MPPT-40**

- Rated for maximum 40 amps of continuous battery current, and 30 amps of continuous load current
- Designed for 12 or 24 VDC systems

### **PS-MPPT-40M**

- Includes metering display
- Rated for maximum 40 amps continuous battery current and 30 amps of continuous load current
- Designed for 12 or 24 VDC systems

## 2.4 Features

The features of the ProStar MPPT are shown in Figure 2-1 below. An explanation of each feature is provided.

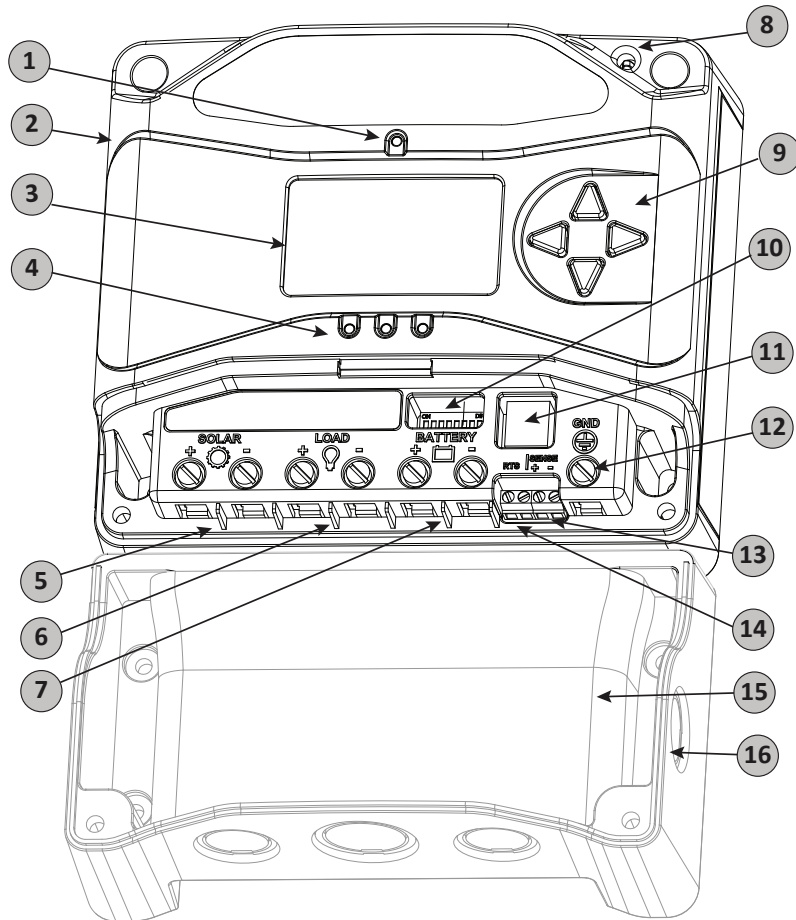

Figure 2-1. PS-MPPT Features

### 1 - Charging Status / Error LED

Shows charging current and error condition statuses.

### 2 - Heatsink

Aluminum heatsink (underneath) to dissipate controller heat (the ProStar MPPT is 100% passively cooled for reliability)

### 3 - Meter Display

Digital LCD monitoring and programming display

### 4 - Battery Status / Fault LED Indicators

Three state of charge (SOC) LED indicators show charging status and controller faults

### 5 - Solar Positive and Negative Terminals

Power connections for Solar (+) and (-) cable terminations

### 6 - Load Positive and Negative Terminals

Power connections for Load (+) and (-) cable terminations

### 7 - Battery Positive and Negative Terminals

Power connections for Battery (+) and (-) cable terminations

### 8 - Local Temperature Sensor

Compensates charging based on ambient temperature (not used if Remote Temperature Sensor is connected)

### 9 - Meter Directional Buttons

Used to navigate throughout meter map

### 10 - DIP Switches

Eight (8) settings switches to configure operation of the ProStar MPPT

### 11 - MeterBus™ Port

RJ-11 socket for Morningstar MeterBus™ network connections

### 12 - Grounding Terminal

Chassis ground terminal for equipment grounding

### 13 - Battery Sense Terminals

Connection points for battery voltage sensing wires

### 14 - Remote Temperature Sensor Terminals (RTS)

Connection points for a Morningstar RTS to remotely monitor battery temperature

### 15 - Wire Box for ProStar-MPPT

Optional accessory to route wiring through knock-outs

### 16 - Wire Box for ProStar-MPPT Knock-outs

Knock-outs for routing wires to conduit or wire gland terminations

## 2.5 Optional Accessories

---

The following accessories are available for purchase separately from your authorized Morningstar dealer:

### Remote Temperature Sensor (Model: RTS)

The RTS measures battery temperature for accurate temperature compensation and is recommended when the ambient battery temperature differs from the ambient controller temperature by more than 5° C. The standard cable length is 33 ft (10m).



**NOTE:** *The use of a Remote Temperature Sensor is strongly recommended. Controller location, air flow, and system power can drastically affect the local temperature sensor reading. An RTS will provide optimal charging performance.*

### RM-1 Meter

The digital Remote Meter displays system operating information, error indications, and self-diagnostic read-out. Information is displayed on a backlit 4-digit custom LCD display. The large numerical display and icons are easy to read and large buttons make navigating the meter menus easy. Additionally, a status LED and three (3) battery SOC LEDs provide system status at a glance.

The meter can be flush mounted in a wall or surface mounted using the mounting frame (included). The RM-1 is supplied with 33 ft (10.0 m) of cable, a mounting frame, and mounting screws. The RM-1 connects to the RJ- 11 Meter port on the ProStar MPPT.

### Ground-fault Protection Device (GFPD-150V)

The GFPD-150V detects power source ground faults and interrupts current as required by the U.S. National Electrical Code.

### Wire Box for ProStar MPPT

A modular wiring box that can be added to any version of ProStar MPPT controller. The box acts as a junction (using knock-outs) to run controller wiring to external conduit, if desired. The wire box cannot be used with rigid conduit. The communications accessories / adaptors below should be housed in the Wire Box for ProStar MPPT.

### Communications Support:

#### Ethernet MeterBus Converter (EMC-1)

This product is an Ethernet gateway that provides web monitoring, a Modbus TCP/IP server, and a local web page server. End users can collect information about their off-grid PV system remotely by bridging MODBUS TCP/IP requests to serve LiveView pages, or connect with MSView monitoring software. The EMC-1 supports all products that have a MeterBus port.

#### USB Communications Adapter (UMC-1)

A modular unit that uses a USB-B plug, usually from a USB A-B computer cable, and an RJ-11 plug to connect with a Morningstar controller's MeterBus port, for monitoring and programming using MSView PC software.

#### PC MeterBus Adapter™ (Model: MSC)

The MSC converts the MeterBus RJ-11 electrical interface to an isolated standard RS-232 interface which enables communication between the ProStar MPPT and a personal computer (PC). The MSC can be used for programming custom charging set-points, and for logging data in MSView. See Section 4.7 for more information on programming.

## 3.0 INSTALLATION INSTRUCTIONS

### 3.1 General Installation Notes

- Read through the entire installation section first before beginning installation.
- Be very careful when working with batteries. Wear eye protection. Have fresh water available to wash and clean any contact with battery acid.
- Use insulated tools and avoid placing metal objects near the batteries.



**WARNING:** *Equipment Damage or Risk of Explosion*

*Never install the ProStar MPPT in an enclosure with vented/flooded batteries. Battery fumes are flammable and will corrode and destroy the ProStar MPPT circuits.*



**CAUTION:** *Equipment Damage*

*When installing the ProStar MPPT in an enclosure, ensure sufficient ventilation. Installation in a sealed enclosure may lead to over-heating and a decreased product lifetime.*



**AVERTISSEMENT:** *Endommagement de l'équipement ou risque d'explosion*

*N'installez jamais le ProStar MPPT dans une enceinte avec des batteries à évent/à électrolyte liquide. Les vapeurs des batteries sont inflammables et corroderont et détruiront les circuits du ProStar MPPT.*



**PRUDENCE:** *Endommagement de l'équipement*

*Assurez une ventilation suffisante en cas d'installation du ProStar MPPT dans une enceinte. L'installation dans une enceinte hermétique peut entraîner une surchauffe et une réduction de la durée de vie du produit.*

- Do not install in locations where water can enter the controller.
- Loose power connections and /or corroded wires may result in resistive connections that melt wire insulation, burn surrounding materials, or even cause fire. Ensure tight connections and use cable clamps to secure cables and prevent them from swaying in mobile applications.
- Preset charging profiles are generally designed for lead acid batteries. Custom settings can be used for varied charging requirements (see sections 3.2 and 4.7 for details). Note that some battery types may not be compatible.
- The ProStar MPPT battery connection may be wired to one battery, or a bank of batteries. The following instructions refer to a singular battery, but it is implied that the battery connection can be made to either one battery or a group of batteries in a battery bank.
- The ProStar MPPT uses stainless steel fasteners, an anodized aluminum heat sink, and conformal coating to protect it from harsh conditions. However, for acceptable service life, extreme temperatures and marine environments should be avoided.
- The ProStar MPPT prevents reverse current leakage at night, so a blocking diode is not required in the system.
- The ProStar MPPT is designed to regulate ONLY solar (photovoltaic) power. Connection to any other type of power source e.g. wind turbine or generator may void the warranty. However, other power sources can be connected directly to the battery.
- (3) ferrite chokes are included for individual installation around an RTS cable, a Meterbus cable and a heat-sink ground wire, if used. Each wire must be looped (at least once) through a ferrite choke, as close to the ProStar MPPT as possible, to meet FCC Class B EMI requirements.

**CAUTION:** For hazardous location IECEx/ATEX applications, see the addendum - part no. MS-003244-EN -to this manual.

**PRUDENCE:** Pour les applications en environnement dangereux - IECEx / ATEX, voir l'addendum - référence MS-003244-FR - à ce Manuel.

**WARNING: Risk of Fire** Battery, load and PV array disconnects and overcurrent protection are required in the system. These protection devices are external to the ProStar MPPT controller. See Section 3.4.2 Required Overcurrent Protection Devices (OCPD) and Disconnect Switches.

**AVERTISSEMENT : Risque d'incendie** Des déconnexions de batterie, de charge et de générateur photovoltaïque et une protection contre les surintensités sont nécessaires dans le système. Ces dispositifs de protection sont externes au contrôleur ProStar MPPT. Voir Section 3.4.2 Dispositifs de protection contre les surintensités (OCPD) et interrupteurs de déconnexion requis.

**WARNING:** Installation must comply with all US National Electrical Code and Canadian Electrical Code requirements.

**AVERTISSEMENT:** Installation doit être conforme à toutes les exigences US National Electrical Code et Code Canadien d'Electricité.

**WARNING:** Minimum over-current protection device interrupt ratings must be 2000A for 12V systems, and 4000A for 24V systems.

**AVERTISSEMENT:** Protection contre les surintensités minimum cotes d'interruption de périphérique doivent être de 2000 a 12V systèmes et 4000 a pour les systèmes de 24V.

## 3.2 Configuration

The DIP switch block shown in Figure 3.1 below is used to set the operating parameters for the ProStar MPPT.

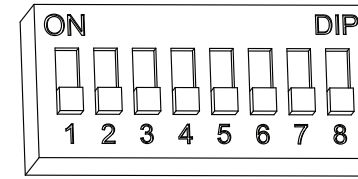

Figure 3.1. DIP Switch Block to set charging parameters

### Switch 1: Load / Lighting

Mode	Switch 1
Normal	OFF
Lighting	ON

### Switches 2, 3: System Voltage

Three (3) system voltage configurations are available as shown in the table below:

System Voltage	Switch 2	Switch 3
Auto	OFF	OFF
12	OFF	ON
24	ON	OFF

**NOTE:** Before connecting the battery, measure the open-circuit voltage. It must be over ten volts to start the controller. If the system voltage Settings Switches are set to Auto-detect, battery voltage over 15.5V will be detected as a 24V nominal battery, and the unit will charge accordingly. The 12/24V auto selection is only done at start-up, and the detected system voltage will never change during operation.

Generally, the specific system voltage is known, and it is best to set DIPs 2,3 accordingly; the auto-detect setting should be used only in rare circumstances.

### Switches 4, 5, 6: Battery Type Selection

Preset ProStar MPPT battery charging options are shown in table 3-1 below. All voltage settings listed are for nominal 12 volt batteries.

Multiply the voltage settings by two (2) for 24 volt systems.

 **NOTE:** These settings are general guidelines for use at the operator's discretion. The ProStar MPPT can be programmed to satisfy a wide range of charging parameters. Consult the battery manufacturer for optimal battery charge settings.

### Battery Charging Set-points (@ 25°C):

[multiply voltages by (2) for 24 volt systems]

DIP Switch Settings 4-5-6	Battery Type	Absorp. Stage (volts)	Float Stage (volts)	Equalize Stage (volts)	Absorp. Time (mins)	Equalize Time (mins)	Equalize Timeout (mins)	Equalize Interval (days)
off-off-off	1 - Sealed*	14.00	13.50		150			
off-off-on	2 - Sealed*	14.15	13.50	14.40	150	60	120	28
off-on-off	3 - Sealed*	14.30	13.50	14.60	150	60	120	28
off-on-on	4- AGM/Flooded	14.40	13.50	15.10	180	120	180	28
on-off-off	5 - Flooded	14.60	13.50	15.30	180	120	180	28
on-off-on	6 - Flooded	14.70	13.50	15.40	180	180	240	28
on-on-off	7 - L-16	15.40	13.40	16.00	180	180	240	14
on-on-on	8 - Custom	Custom	Custom	Custom	Custom	Custom	Custom	Custom

\* "Sealed" battery type includes gel and AGM batteries

Table 3.1. Battery charging settings for each selectable battery type

### Switch 7: Battery Equalization

Mode	Switch 7
Manual Equalization	OFF
Auto Equalization	ON

### Switch 8: Meterbus / MODBUS Settings

Mode	Switch 8
Meterbus	OFF
MODBUS	ON

### 3.3 Mounting

Inspect the controller for shipping damage. Mount the ProStar MPPT to a vertical surface (4-#8 stainless steel self-tapping screws are included). Tighten the mounting screws, using care not to crack the plastic case. Do not install directly over an easily combustible surface since the heat sink may get hot under certain operating conditions.

For proper air flow, allow at least 15 cm (6 in) of space above and below the controller, and 50 mm (2 in) at the sides - see Figure 3-2 below. Do not locate in an enclosure where battery gases can accumulate.



**NOTE:** The heat sink must be in a vertical position (fins up and down).

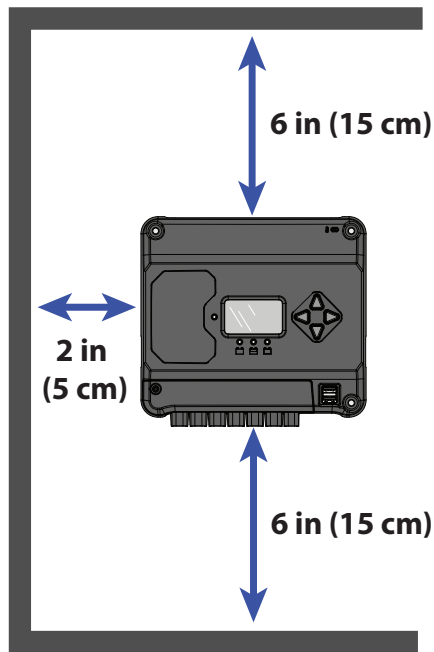

Figure 3-2. Proper Clearances for Passive Cooling

### 3.4 Wiring



#### **CAUTION: Code Requirements**

*U.S. installed wiring must conform to all current U.S. NEC, ANSI/NFPA 70 requirements, and to any local regulations. Non-U.S. installations must meet all national and local requirements of the country of installation.*



#### **ATTENTION : Exigences du code**

*Le câblage installé aux États-Unis doit être conforme à toutes les exigences actuelles du NEC, de l'ANSI/NFPA 70 aux États-Unis et à toute réglementation locale. Les installations non américaines doivent répondre à toutes les exigences nationales et locales du pays.*

### 3.4.1 Wire Sizing

The power terminals are sized for #14 - 2 AWG (2.5 - 35 mm<sup>2</sup>) wire. When inside an enclosure (maintenance access only) and using the Wire Box accessory, or without the terminal cover, the maximum wire size of #2 AWG can be used. With the standard terminal cover, the maximum power terminal wire size is #6 AWG (16 mm<sup>2</sup>) with multi-stranded wire, or #8 AWG (10 mm<sup>2</sup>) with fine-stranded wire. Use an insulated flathead screwdriver, and torque tightly up to 35 in-lb.

The terminals are rated for copper and aluminum conductors. Use UL-listed Class B or Class C stranded wire rated for 300 Volt and 75C or higher. Copper is recommended due to the ease of use, good conductivity, strength and lower thermal expansion properties.

It is critical that the ampacity (or current carrying capacity) of conductors is sufficient to handle the maximum current of the power circuits. Good system design generally requires large conductor wires that limit voltage drop losses to 2% or less.

**See Appendix C - Voltage Drop (distances) Tables - for minimum copper wire sizing to achieve maximum 2% voltage drops.**



#### **WARNING: Fire Hazard**

*If multiple units are used in parallel for more charging current, the battery conductor wiring must be sized for the total sum of all current ratings of the combined controllers.*





#### **AVERTISSEMENT : Risque d'incendie**

*Si plusieurs unités sont utilisées en parallèle pour plus de courant de charge, le câblage du conducteur de la batterie doit être dimensionné pour la somme totale de tous les courants nominal des contrôleurs combinés.*

### 3.4.2 Required Overcurrent Protection Devices (OCPD) and Disconnect Switches

 **WARNING: Risk of Fire and Shock**  
Battery, load and PV array overcurrent protection (breakers or fuses) are required in the system. These protection devices are external to the ProStar MPPT controller, and must be sized as required by the NEC or local code requirements.

 **AVERTISSEMENT : Risque d'incendie et choc**  
Une protection contre les surintensités de la batterie, de la charge et du générateur photovoltaïque (disjoncteurs ou fusibles) est requise dans le système. Ces dispositifs de protection sont externes au programmeur ProStar MPPT et doivent être dimensionnés conformément aux exigences du NEC ou du code local.

 **WARNING: Risk of Fire and Shock**  
The PV system requires a means of disconnecting the battery, load and PV array. Breaker switches or disconnect switches can serve as a disconnecting means and should be located at a readily accessible location. For best practices and safety guidance see NEC 690 "Part III - Disconnecting Means" for disconnect requirements for PV systems in addition to other code requirements.

 **AVERTISSEMENT : Risque d'incendie et de choc**  
Le système PV nécessite un moyen de déconnecter la batterie, la charge et le générateur PV. Les disjoncteurs ou les sectionneurs peuvent servir de moyens de déconnexion et doivent être situés à un endroit facilement accessible. Pour les meilleures pratiques et les conseils de sécurité, voir NEC 690 "Partie III - Disconnecting Means" pour les exigences de déconnexion des systèmes PV en plus des autres exigences du code.

 **WARNING: Risk of Fire and Shock**  
Fuses, single-pole circuit breakers, or single-pole disconnect switches must only be installed on ungrounded system conductors. The NEC allows and may require the use of double-pole breakers or double-pole disconnect switches which break both the grounded and ungrounded conductors of the PV array.

 **AVERTISSEMENT : Risque d'incendie et choc**  
Les fusibles, les disjoncteurs unipolaires ou les sectionneurs unipolaires ne doivent être installés que sur des conducteurs de système non mis à la terre. Le NEC autorise et peut exiger l'utilisation de disjoncteurs bipolaires ou de sectionneurs bipolaires qui coupent à la fois les conducteurs mis à la terre et non mis à la terre du générateur photovoltaïque.

#### BATTERY DISCONNECT AND OVER-CURRENT PROTECTION DEVICE SIZING

The U.S. NEC requires the installation of DC breakers or fused disconnect switches in all battery circuits in order to provide both a means of disconnection and overcurrent protection.

The battery breaker or fused disconnect switch(es) should be located near the battery or the battery busbar. Where the controller battery terminals are more than 1.5m (5 feet) from the battery, or where circuits from these terminals pass through a wall or partition, U.S. NEC requires that a means of disconnection be provided at the battery and solar controller.

The minimum battery disconnect switch current rating is the current rating of the controller being installed. To provide over-current protection when using a disconnect switch, a properly sized fuse or breaker must be installed in series. Battery breakers or fuses must be sized with a minimum of



125% of the continuous output current rating of the solar controller. Recommended battery circuit fuse or breaker current ratings:

PS-MPPT-25: 40 Amps

PS-MPPT-40: 50 Amps

## PV INPUT DISCONNECT AND OVER-CURRENT PROTECTION DEVICE SIZING



### **WARNING: Risk of Fire and Shock**

The solar array open-circuit voltage (Voc) at the worst-case (coldest) module temperature must not exceed the PV disconnect or overcurrent protection voltage ratings.



### **AVERTISSEMENT : Risque d'incendie et choc**

La tension en circuit ouvert du générateur solaire (Voc) à la température de module la plus défavorable (la plus froide) ne doit pas dépasser les valeurs nominales de tension de déconnexion PV ou de protection contre les surintensités.

As defined in NEC Section 690.9, PV input disconnect switches must have a current rating greater than or equal to the maximum PV array current (1.25 X PV array Isc). PV array Isc = # of strings multiplied by the module Isc (STC) rating. Note that individual PV string circuits do not require disconnects.

NEC Section 690.9 also provides requirements for overcurrent protection. The PV input breaker or fuse current rating should not be less than the next higher breaker rating above 125% of the maximum PV array current (156% of the PV array Isc). Maximum PV breaker or fuse ratings are:

PS-MPPT-25: 40 Amps

PS-MPPT-40: 50 Amps

String over-current protection is also required for parallel strings and are typically included with the PV string combiner. There may be other code requirements specific to the installation of a particular PV array.

If 156% of PV array Isc is greater than the maximum PV input breaker or fuse current rating, the PV array breaker or fuse should be located at the output of the PV array combiner.

## LOAD DISCONNECT AND OVER-CURRENT PROTECTION DEVICE SIZING

The load output breaker or fused disconnect switch should be near the load output terminals of the controller. Load fuses should be installed between the controller output and the load disconnect.

The load output disconnect switch must have a minimum current rating  $\geq$  the fuse current rating but is not required to be higher than the load output current rating of the controller.

The load fuse or breaker should be sized with a minimum of 125% of the maximum load output current. The maximum load output current is the sum of the branch load circuits or the controller load output current rating.

The maximum load output breaker or fuse current rating is:

PS-MPPT-25: 40 Amps

PS-MPPT-40: 40 Amps

### 3.4.3 Wiring Connections

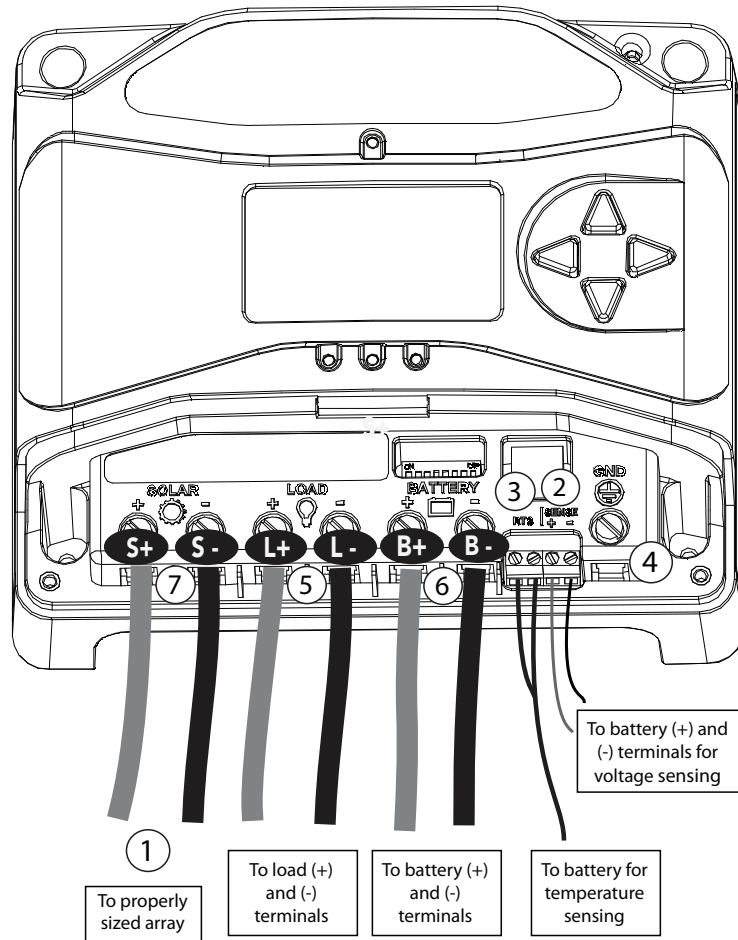

Figure 3-3. Wiring the PS-MPPT

**REFER TO FIGURE 3.3 WHEN USING THE WIRING INSTRUCTIONS BELOW.**

**NOTE:** THE PS-MPPT IS UL 1741 COMPLIANT WHEN USED WITH THE OPTIONAL WIRE BOX. THE WIRE BOX CANNOT BE USED WITH RIGID CONDUIT. THE PS-MPPT IS UL RECOGNIZED FOR USE IN A UL LISTED ASSEMBLY WITHOUT THE WIRE BOX FOR THE PS-MPPT.

#### STEP 1: Check Controller Limitations

Verify that the highest temperature compensated solar array open-circuit voltage (Voc), and load current do not exceed the ratings of the ProStar MPPT version being installed.

Multiple controllers can be installed in parallel on the same battery bank to achieve greater total charging current. In this type of system, each ProStar MPPT must have its own solar array. The load terminals of multiple controllers can only be wired together if the total load draw does not exceed the nameplate current of the LOWEST rated controller.

#### STEP 2: Battery Voltage Sense Wires



**WARNING: Fire Hazard**

When connecting Battery Sense Wires, install a 5 Amp fuse in the (+) sense wire, six inches from the (+) battery terminal.



**AVERTISSEMENT : Risque d'incendie**

Lors de la connexion des câbles de détection de batterie, installez un fusible de 5 A dans le câble de détection (+), à six pouces de la borne de la batterie (+).

Due to connection and cable resistance, voltage drops are unavoidable in power cables that carry current, including the ProStar MPPT battery cables. If Battery Sense wires are not used, the controller must use the voltage reading at the battery power terminals for regulation. This voltage may differ from the actual battery bank voltage due to voltage drop.

The Battery Voltage Sense connection enables the ProStar MPPT to measure the voltage at the battery terminals accurately with no voltage drop.

Generally accepted wiring practice is to limit voltage drops between the charger and the battery to 2%. Even properly sized wiring with 2% drop can result in a 0.3 volt drop for 14.4V charging. Voltage drops will cause some undercharging of the battery.

The controller will begin Absorption or limit equalization at a lower battery voltage because the controller measures a higher voltage at the controller's terminals than is the actual battery voltage. For example, if the controller is programmed to start Absorption at 14.4V, when the controller "sees" 14.4 volts at its battery terminals, the true battery voltage would only be 14.1 volts, if there is a 0.3 volt drop between the controller and battery.

Note that the battery sense wires will not power the controller, and the sense wires will not compensate for losses in the power wires between the controller and the battery. The battery sense wires are used to improve the accuracy of the battery charging.

The two sense wires, can range in size from 1.0 to 0.25 mm<sup>2</sup> (16 to 24 AWG), and should be cut to length as required to connect the battery to the voltage sense terminals. A 2-position terminal (see figure 3.3) is used for the battery sense connection. A twisted pair cable is recommended but not required. Use UL rated 300 Volt conductors. The voltage sense wires may be pulled through conduit with the power conductors.

Observing correct polarity, connect both battery voltage sense wires to the ProStar MPPT at the 2-position *Battery Sense* terminal, and to battery (+) and (-) terminals. No damage will occur if the polarity is reversed, but the controller cannot read a reversed sense voltage.

Tighten the connector screws to 5 in-lb (0.56 Nm) of torque. The maximum length allowed for each battery voltage sense wire is 98 ft (30 m).

Connecting the voltage sense wires to the RTS terminal will cause an alarm.

 **NOTE:** If the battery input voltage is greater than 5 volts different than the *Battery Sense*, due to voltage drops or faulty connections, the *Battery Sense* input will not be recognized by the ProStar MPPT.

A battery voltage sense connection is not required to operate the ProStar MPPT controller, but it is recommended for best performance.

### STEP 3: Remote Temperature Sensor



**WARNING: Risk of Fire.**

*If no Remote Temperature Sensor (RTS) is connected, use the ProStar MPPT within 3m (10 ft) of the batteries. Internal Temperature Compensation will be used if the RTS is not connected. Use of the RTS is strongly recommended.*



**AVERTISSEMENT: Risque d'incendie.**

*Si non Capteur de température distant (RTS) est connecté, utilisez le MPPT ProStar moins de 3m (10 pi) de les batteries. Compensation de la température interne sera utilisée si la RTS n'est pas connecté. Utilisation de la RTS est fortement recommandé.*

All charging settings are based on 25°C (77°F). If the battery temperature varies by 5°C, the charging setting will change by 0.15 Volts for a 12 Volt battery. This is a substantial change in the charging of the battery, and the use of the optional Remote Temperature Sensor (RTS) is recommended to adjust charging to the actual battery temperature. The RTS can be added at any time after the system has been installed.

Connect the RTS to the 2-position terminal located between the battery (-) and chassis ground terminal lugs (see figure). The RTS is supplied with 33 ft (10 m) of 22 AWG (0.34 mm<sup>2</sup>) cable. There is no polarity, so either wire (+ or -) can be connected to either screw terminal. The RTS cable may be pulled through conduit along with the power wires. Tighten the connector screws to 5 in-lb (0.56 Nm) of torque. Separate installation instructions are provided inside the RTS bag.





**WARNING: Equipment Damage**

*Never place the temperature sensor inside a battery cell. Both the RTS and the battery will be damaged.*

 **AVERTISSEMENT:** *Endommagement de l'équipement*  
Ne placez jamais la sonde de température dans un élément de batterie. Le RTS et la batterie seraient endommagés.

 **CAUTION:** *The ProStar MPPT will use the local temperature sensor for compensation if the RTS is not used.*

 **PRUDENCE:** *Le ProStar MPPT ne compense pas la température des paramètres de charges si le RTS n'est pas utilisé.*

 **NOTE:** *The RTS cable may be shortened if the full length is not needed. Be sure to reinstall the ferrite choke on the end of the RTS if a length of cable is removed. This choke ensures compliance with electromagnetic emissions standards.*

 **REMARQUE:** *Le câble de RTS peut être raccourci si la totalité de la longueur n'est pas nécessaire. Assurez-vous de réinstaller la bobine en ferrite sur l'extrémité du RTS si une longueur de câble est enlevée. Cette bobine assure la conformité avec les normes d'émissions électromagnétiques.*

#### STEP 4: Grounding and Ground Fault Interruption

 **WARNING:**  
*This unit is not provided with a GFDI device. This charge controller must be used with an external GFDI device as required by the Article 690 of the National Electrical Code for the installation location.*

 **NOTE:**  
*Depending on the country of installation, conductors identified by the color green, or a combination of green/yellow, shall only be used for earthing conductors.*

 **AVERTISSEMENT :**  
*L'appareil n'est pas fourni avec un dispositif GFDI. Ce contrôleur de charge doit être utilisé avec un appareil GFDI externe comme requis par le code local ou les références*

Use copper wire to connect the grounding terminal in the case, and other dead metal, to earth ground. The grounding terminal is identified by the ground symbol on the case, just above the terminal, as shown below:

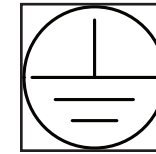

Figure 3-4. Ground Symbol

Per NEC 690.45 (A) and NEC Table 250.122, minimum sizes for equipment copper grounding wire are:

- ProStar MPPT-25 10 AWG (5 mm<sup>2</sup>)
- ProStar MPPT-40 10 AWG (5 mm<sup>2</sup>)

Per IEC 62109, minimum sizes for equipment copper grounding wire are:

- ProStar MPPT-25 7 AWG (10 mm<sup>2</sup>)
- ProStar MPPT-40 7 AWG (10 mm<sup>2</sup>)

OR, of the same, or greater, cross-sectional area as the PV wires.



**WARNING:** *Risk of Fire*

*DO NOT bond DC system electrical negative to earth grounding terminal on the controller. Per NEC, system negative must be bonded to earth ground at only one point, and through a GFPD if required.*



**AVERTISSEMENT :** *Risque d'incendie*

*NE LIEZ PAS le côté négatif du système à la mise à la terre au niveau du contrôleur. Selon les exigences par le code local ou les références, le côté négatif du système doit être mis à la terre par un GFPD à un seul point.*

For safety, and effective lightning protection, it is recommended, and may be required by code, that the negative conductor of the charging system be properly grounded. Do not connect the grounding electrode

conductor (GEC) to the case ground terminal. The ProStar MPPT does not have internal ground fault protection; but where the NEC requires the use of a ground fault protection device (GFPD), the system electrical negative should be bonded through a GFPD to earth ground at only one point. The grounding point may be located in the solar, or the battery circuit. For system grounding electrode conductor sizing requirements, refer to the NEC Section 690.47, or applicable local regulations or code.

**STEP 5: Battery Connections** - see diagram below

Be sure that DIP switches 2 and 3 are set for 12 or 24V, as described in Section 3.2

**NOTE:** Before connecting the battery, measure the open-circuit voltage. It must be over 10 volts to start the controller. If the system voltage Settings Switches are set to Auto-detect, battery voltage over 15.5V will be detected as a 24V nominal battery, and the unit will charge accordingly. The 12/24V auto selection is only done at start-up.

With an OPEN battery OCPD, connect the battery (-) wire from the battery to the controller battery (-) terminal. Connect the battery (+) wire from the battery to the OCPD, and then connect a wire from the battery OCPD to the controller battery (+) terminal. If wiring a fuse and disconnect switch install the fuse on the battery side of the disconnect switch. **DO NOT CLOSE THE BATTERY OCPD AT THIS TIME.**

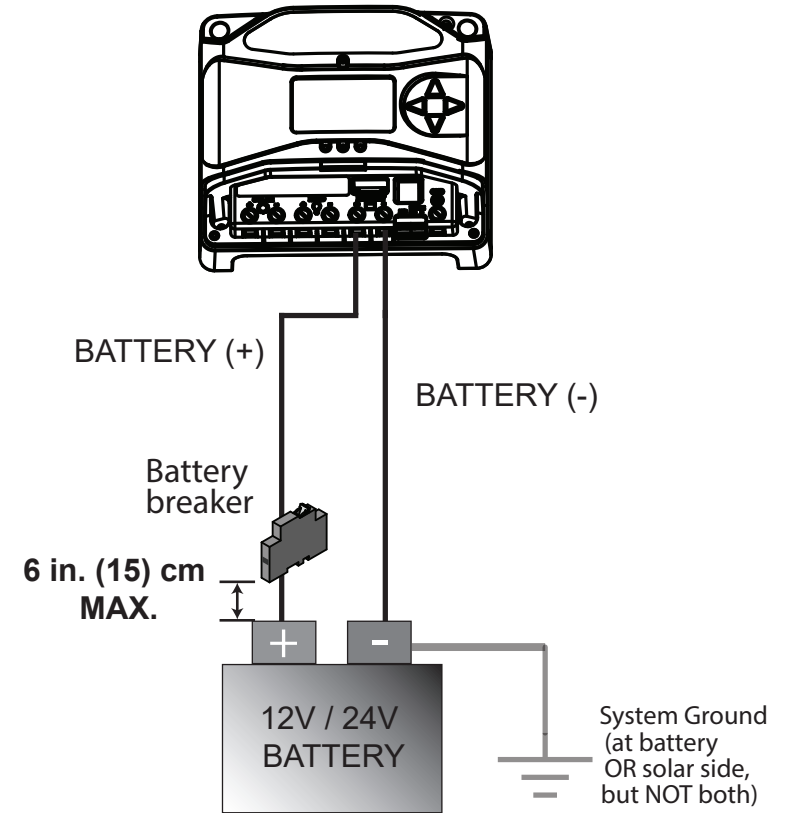

**STEP 6: Solar Connections** - see diagram below



**WARNING: Shock Hazard**

Depending on the array configuration, the solar PV array can produce open-circuit voltages of up to 120 Vdc when in sunlight. Verify that the solar input breaker or disconnect is open (disconnected), and combiner fuses (if installed) removed before installing the system wires. The PV modules should be connected last to avoid voltage in the rest of the PV circuit during wiring.



**AVERTISSEMENT : Risque de Choc**

Selon la configuration du générateur, le générateur solaire PV peut produire des tensions en circuit ouvert allant jusqu'à 120 Vdc lorsqu'il est exposé au soleil. Vérifiez que

le disjoncteur ou le sectionneur d'entrée solaire est ouvert (déconnecté) et que les fusibles du combinateur (le cas échéant) ont été retirés avant d'installer les câbles du système. Les modules PV doivent être connectés en dernier pour éviter toute tension dans le reste du circuit PV pendant le câblage.

With an OPEN solar OCPD, connect the solar (PV) array wires to the PS-MPPT solar terminals. Connect a PV (-) wire from the controller (-) terminal to the PV array (-). Connect a PV (+) wire from the controller to the PV OCPD. Then connect a PV (+) wire from the OCPD to the PV array (+). If required, install the combiner and/or ground fault protection wiring (not shown) according to the manufacturer's instructions.

Use caution, since the solar array can produce voltage and current whenever in sunlight. DO NOT CLOSE THE PV OCPD AT THIS TIME.

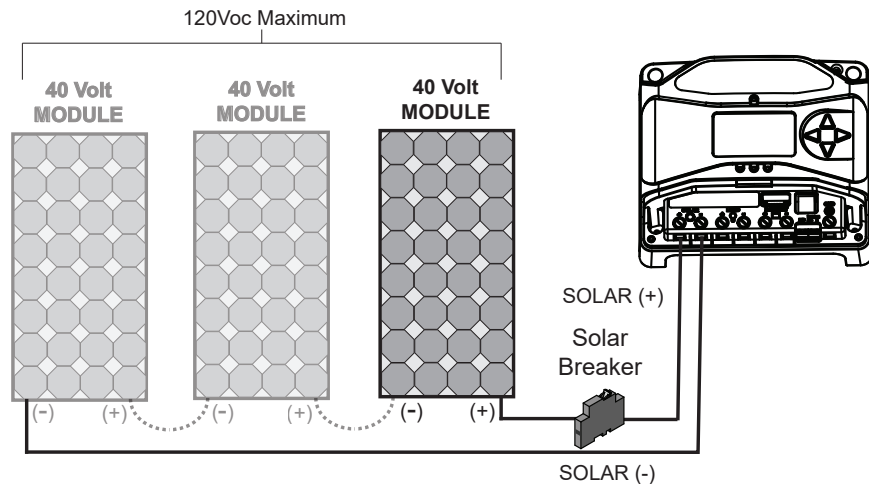

### STEP 7: Load Connections - see diagram below



#### **CAUTION: Equipment Damage**

Do not wire any AC inverter to the load terminals of the ProStar MPPT. Damage to the load control circuit may result. An inverter should be wired to the battery. If there is a possibility that any other load will sometimes exceed the Prostar MPPT's maximum voltage or current limits, the device should be wired directly to the battery or battery bank. If load control is

required, contact Morningstar Tech Support for assistance.



#### **PRUDENCE : Dommages matériels**

Ne pas raccorder n'importe quel convertisseur aux bornes de la ProStar MPPT. Pourrait endommager le circuit de commande de charge. S'il y a une possibilité que n'importe quelle autre charge dépassera parfois la tension maximale de la Prostar MPPT ou limites de courant, l'appareil doit être câblé directement sur la batterie ou la batterie. Si le régulateur de charge est nécessaire, contacter le Support technique de Morningstar d'assistance.

Turn the loads off, install an OPEN load OCPD, and connect load wires - observing correct polarity - as shown below. DO NOT CLOSE THE LOAD OCPD AT THIS TIME.

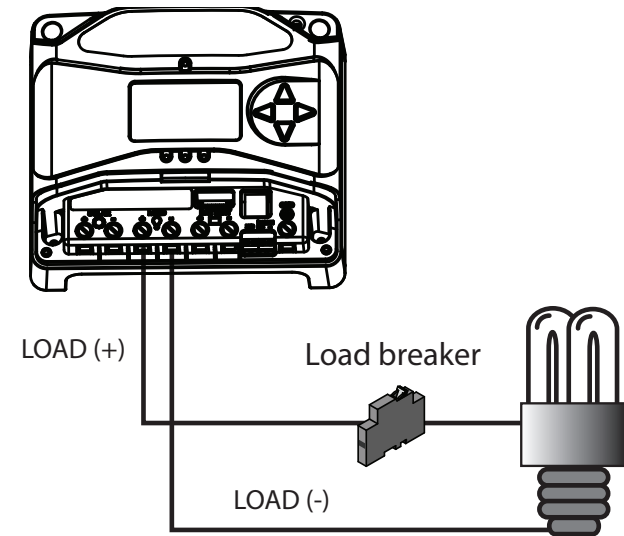

### STEP 8: Power-Up and Verify System Operation



**NOTE:** Carefully observe the LEDs after each connection. The LEDs will indicate proper polarity and a good connection.

Close the battery breaker to power on the controller. Watch the the charging status, and then the three battery state-of-charge (SOC) LEDs blink in sequence (G-Y-R), confirming proper start-up. If they do not light, check the battery polarity (+/-) and battery voltage.

Next, the green, yellow or red LED will light depending on the battery state-of-charge (SOC). Confirm that one of these LEDs is on before going to the next step.

Close the solar disconnect. If the solar input is connected while in sunlight, the charging LED indicator will light.

Confirm proper connection by observing the charging LED.

Close the load disconnect, and turn the load on, to confirm a proper connection.

If the load does not turn on, it could be for various reasons:

- the ProStar MPPT is in LVD (red LED on)
- there is a short circuit in the load (LEDs blinking R/G – Y)
- there is an overload condition (LEDs blinking R/Y - G)
- the load is not connected, not working, or turned off

After all connections have been completed, observe the LEDs to make sure the controller is operating normally for system conditions. If the optional digital meter is used, observe that the display is scrolling with proper voltage and current values. Also, a self- test can be performed with digital meter units.

#### STEP 9: To Power-down



#### **WARNING: Risk of Damage**

*ONLY disconnect the battery from the ProStar MPPT AFTER the solar input has been disconnected. Damage to the controller may result if the battery is removed while the ProStar MPPT is charging.*



#### **AVERTISSEMENT: Risque d'endommagement**

*Le ProStar MPPT 150V SEULEMENT déconnecter la batterie APRÈS l'entrée solaire a été déconnectée. Le contrôleur pourrait endommager si la batterie est retirée quand le ProStar MPPT 150V est en charge.*

- To prevent damage, power-down must be done in the reverse order as power-up.

### 4.1 TrakStar™ MPPT Technology

The ProStar MPPT utilizes Morningstar's TrakStar Maximum Power Point Tracking technology to extract maximum power from the solar module(s). The tracking algorithm is fully automatic and does not require user adjustment. Trakstar technology will track the array maximum power point voltage (Vmp) as it varies with weather conditions, ensuring that maximum power is harvested from the array through the course of the day.

Current Boost:

In many cases, TrakStar MPPT technology will "boost" the solar charge current. For example, a system may have 2 amps of solar current flowing into the ProStar MPPT and 5 amps of charge current flowing out to the battery. The ProStar MPPT does not create current! Rest assured that the power into the ProStar MPPT is the same as the power out of the ProStar MPPT. Since power is the product of voltage and current (Volts x Amps), the following is true\*:

(1) Power Into the ProStar MPPT = Power Out of the ProStar MPPT

(2) Volts In x Amps In = Volts Out x Amps Out

\* assuming 100% efficiency i.e. if no losses in wiring and conversion existed.

If the solar module's Vmp is greater than the battery voltage, it follows that the battery current must be proportionally greater than the solar input current so that input and output power are balanced. The greater the difference between the maximum power voltage and battery voltage, the greater the current boost. Current boost can be substantial in systems where the solar array is of a higher nominal voltage than the battery as described in the next section.

## High Voltage Strings and Grid-tie Modules

Another benefit of TrakStar MPPT technology is the ability to charge 12 or 24 volt batteries with solar arrays of higher nominal voltages. A 12 volt battery bank can be charged with a 12, 24, 36 or 48V nominal off-grid solar array. Certain grid-tie solar modules may also be used as long as the solar array open circuit voltage ( $V_{oc}$ ) rating will not exceed the ProStar MPPT 120V maximum input voltage rating at worst-case (lowest) module temperature. The solar module documentation should provide  $V_{oc}$  vs. temperature data. Higher solar input voltage results in lower solar input current for a given input power. High voltage solar input strings allow for smaller gauge solar wiring. This is especially helpful for systems with long wiring runs between the solar array and the ProStar MPPT.

## An Advantage Over Traditional Controllers

Traditional controllers connect the solar module directly to the battery when recharging. This requires that the solar module operate in a voltage range that is below the module's  $V_{mp}$ . In a 12V system, for example, the battery voltage may range from 10 - 15 Vdc but the module's  $V_{mp}$  is typically around 17V. Figure 4.1 shows a typical current vs. voltage output curve for a nominal 12V off-grid module.

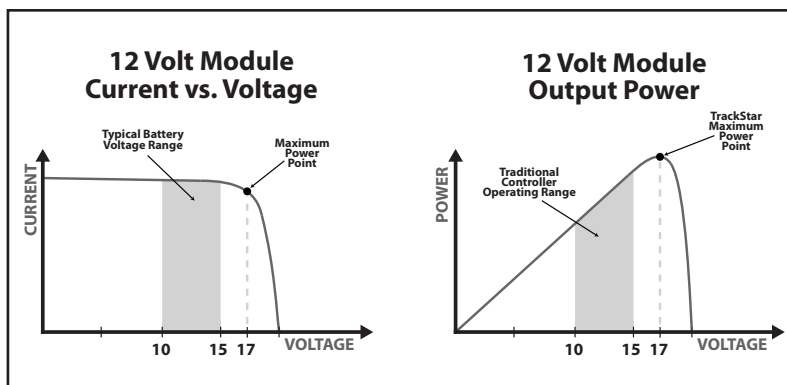

Figure 4.1. Nominal 12 volt solar module I-V curve and output power graph

## 4.2 Battery Charging

### 4-Stage Charging

The ProStar MPPT has a 4-stage battery charging algorithm for rapid, efficient, and safe battery charging. Figure 4-2 shows the sequence of stages.

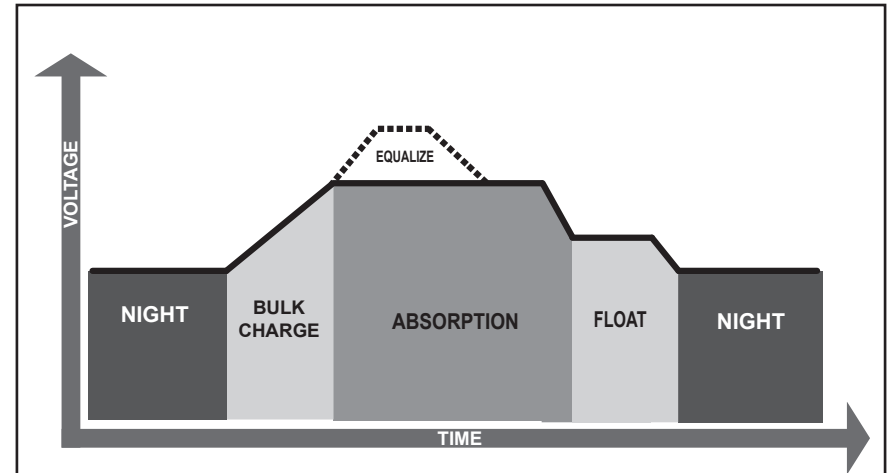

Figure 4.2. ProStar MPPT Charging Algorithm

### Bulk Charge Stage

During Bulk charging, the battery is not at 100% state of charge and battery voltage has not yet charged to the Absorption voltage set-point. The controller will deliver 100% of available solar power to recharge the battery.

### Absorption Stage

When the battery has recharged to the Absorption voltage set-point, constant-voltage regulation is used to maintain battery voltage at the Absorption set-point. This prevents heating and excessive battery gassing. The battery is allowed to come to full state of charge at the Absorption voltage set-point. The green SOC LED will blink once per second during Absorption charging.



The battery must remain in the Absorption charging stage for a cumulative 150-180 minutes, depending on battery type, before transition to the Float stage will occur. However, Absorption time will be extended by 30 minutes if the battery discharges below 12.50 volts (12V system) the previous night.

The Absorption set-point is temperature compensated through either the on-board local temperature sensor, or an optional Remote Temperature Sensor (RTS), if connected.

### Float Stage

After the battery is fully charged in the Absorption stage, the ProStar MPPT reduces the battery voltage to the Float voltage set-point. When the battery is fully recharged, there can be no more chemical reactions and all the charging current is turned into heat and gassing. The float stage provides a very low rate of maintenance charging while reducing the heating and gassing of a fully charged battery. The purpose of float is to protect the battery from long-term overcharge. The green SOC LED will blink once every two (2) seconds during Float charging.

Once in Float stage, loads can continue to draw power from the battery. In the event that the system load(s) exceed the solar charge current, the controller will no longer be able to maintain the battery at the Float set-point. Should the battery voltage remain below the Float set-point for a cumulative 60 minute period, the controller will exit Float stage and return to Bulk charging.

The Float set-point is temperature compensated through either the on-board local temperature sensor, or an optional Remote Temperature Sensor (RTS), if connected.

### Equalization Stage



**WARNING: Risk of Explosion**

Equalizing vented batteries produces explosive gases. The battery bank must be properly ventilated.



**CAUTION: Equipment Damage**

Equalization increases the battery voltage to levels that may damage sensitive DC loads. Verify all system loads are rated for the temperature compensated Equalize voltage before beginning an Equalization charge.



**CAUTION: Equipment Damage**

Excessive overcharging and gassing too vigorously can damage the battery plates and cause shedding of active material from the plates. An equalization that is too high or for too long can be damaging. Review the requirements for the particular battery being used in your system.



**AVERTISSEMENT: Risque d'explosion**

Les batteries à évent et compensation produisent des gaz explosifs. Le groupe de batteries doit être correctement ventilé.



**PRUDENCE: Endommagement de l'équipement**

La compensation augmente la tension des batteries à des niveaux pouvant endommager les charges sensibles en CC. Vérifiez que toutes les charges du système sont conçues pour la tension de compensation par température avant de commencer une charge de compensation.



**PRUDENCE: Endommagement de l'équipement**

Une surcharge excessive et un dégagement gazeux trop vigoureux peuvent endommager les plaques de batteries et provoquer l'élimination du matériau actif des plaques. Une compensation trop élevée ou trop longue peut provoquer des dégâts. Examinez les exigences pour la batterie particulière utilisée dans votre système.

Certain battery types benefit from a periodic boost charge to stir the electrolyte, level the cell voltages, and complete the chemical reactions. Equalization (EQ) charging raises

the battery voltage above the standard absorption voltage so that the electrolyte gases. The green SOC LED will blink rapidly two (2) times per second during equalization charging. The duration of the equalize charge is determined by the selected battery type. See table 4-1 in this section for more details. The *Equalization Time* is defined as time spent at the equalization set-point. If there is insufficient charge current to reach the equalization voltage, the EQ will terminate after an additional 60 minutes to avoid over gassing or heating of the battery. If the battery requires more time in equalization, with non-metered versions, manual EQ can be activated using the push-button (see Section 4.5) to continue for one or more additional EQ cycles. The ProStar MPPT meter, or MSView software, can also be used to program EQ timing and duration.

The Equalization set-point is temperature compensated through either the on-board local temperature sensor, or an optional Remote Temperature Sensor (RTS), if connected.

### Why Equalize?

Routine equalization cycles are often vital to the performance and life of a battery - particularly in a solar system. During battery discharge, sulfuric acid is consumed and soft lead sulfate crystals form on the plates. If the battery remains in a partially discharged condition, the soft crystals will turn into hard crystals over time. This process, called "lead sulfation", causes the crystals to become harder over time and more difficult to convert back to soft active materials. Sulfation from chronic undercharging of the battery is the leading cause of battery failures in solar systems. In addition to reducing the battery capacity, sulfate build-up is the most common cause of buckling plates and cracked grids. Deep cycle batteries are particularly susceptible to lead sulfation.

Normal charging of the battery can convert the sulfate back to the soft active material if the battery is fully recharged. However, a solar battery is seldom completely recharged, so the soft lead sulfate crystals harden over a period of time.

Only a long controlled overcharge, or equalization, at a higher voltage can reverse the hardening of sulfate crystals.

### When to Equalize?

The ideal frequency of equalizations depends on the battery type (lead-calcium, lead-antimony, etc.), the depth of discharging, battery age, temperature, and other factors. One very broad guide is to equalize flooded batteries every 1 to 3 months or every 5 to 10 deep discharges. Some batteries, such as the L-16 group, will need more frequent equalizations.

The difference between the highest cell and lowest cell in a battery can also indicate the need for an equalization. Either the specific gravity or the cell voltage can be measured. The battery manufacturer can recommend the specific gravity or voltage values for your particular battery.

### Preparation for Equalization

First, confirm that all of the system loads are rated for the equalization voltage. Consider that at 0°C (32°F) the equalization voltage will reach 16.75 volts for L-16 batteries with a temperature sensor installed. Disconnect any loads at risk of damage due to the high input voltage.

If Hydrocaps are used, be sure to remove them before starting an equalization. Replace the Hydrocaps with standard battery cell caps. The Hydrocaps can get very hot during an equalization. Also, if Hydrocaps are used, the equalization should be set for manual only (DIP switch #7 is Off).

After the equalization is finished, add distilled water to each cell to replace gassing losses. Check that the battery plates are covered.

### Equalize a Sealed Battery?

The *Battery Charging Settings* table (see table 4-1 in this section) shows two sealed battery settings with an Equalization cycles. These are minimal "boost" cycles to level individual cells. This is not an equalization, and will not vent gas from sealed batteries that require up to 14.4V

charging (12V battery). Many VRLA batteries, including AGM and gel, have charging requirements up to 14.4V (12V battery). Depending on the battery manufacturer's recommendation, the "boost" cycle for sealed cells can be disabled by setting the equalize setting switch to manual, if required.

### Battery Charge Settings

Preset ProStar MPPT battery charging options are shown in tables 4-1 and 4-2 below. All voltage settings listed are for nominal 12 Volt batteries. Multiply the voltage settings by two (2) for 24 Volt batteries.

 **NOTE:** These settings are general guidelines for use at the operator's discretion. The ProStar MPPT can be programmed to satisfy a wide range of charging parameters. Consult the battery manufacturer for optimal battery charge settings.

### Battery Charging Set-points (@ 25°C):

[multiply voltages by (2) for 24 volt systems]

DIP Switch Settings 4-5-6	Battery Type	Absorp. Stage (volts)	Float Stage (volts)	Equalize Stage (volts)	Absorp. Time (mins)	Equalize Time (mins)	Equalize Timeout (mins)	Equalize Interval (days)
off-off-off	1 - Sealed*	14.00	13.50		150			
off-off-on	2 - Sealed*	14.15	13.50	14.40	150	60	120	28
off-on-off	3 - Sealed*	14.30	13.50	14.60	150	60	120	28
off-on-on	4- AGM/Flooded	14.40	13.50	15.10	180	120	180	28
on-off-off	5 - Flooded	14.60	13.50	15.30	180	120	180	28
on-off-on	6 - Flooded	14.70	13.50	15.40	180	180	240	28
on-on-off	7 - L-16	15.40	13.40	16.00	180	180	240	14
on-on-on	8 - Custom	Custom	Custom	Custom	Custom	Custom	Custom	Custom

\* "Sealed" battery type includes gel and AGM batteries

Table 4.1. Battery charging settings for each selectable battery type

Shared Settings	Value	Units
Absorption Extension Voltage	12.50	Volts
Absorption Extension Time	Absorption Time + 30	minutes
Float Exit Time-out	60	minutes
Float Cancel Voltage	12.10	Volts
Equalize Time-out	Equalize Time + 60	minutes
Temperature Compensation Co-efficient	- 30	millivolts / °C / 12V

Table 4.2. Battery settings that are shared among all battery types

The ProStar MPPT provides seven (7) standard battery charging settings that are selected with the settings switches (see Table 4.1 above). These standard charging settings are suitable for lead-acid batteries ranging from sealed (gel, AGM, maintenance-free) to Flooded and L-16 cells. In addition, an eighth charging setting provides for custom set-points using MSView™ PC software. Table 4-1 above summarizes the major parameters of the standard charging settings. The shared settings in Table 4-2 are common to all battery types. The following charging profiles graphically illustrate the shared settings:

### Absorption Extension

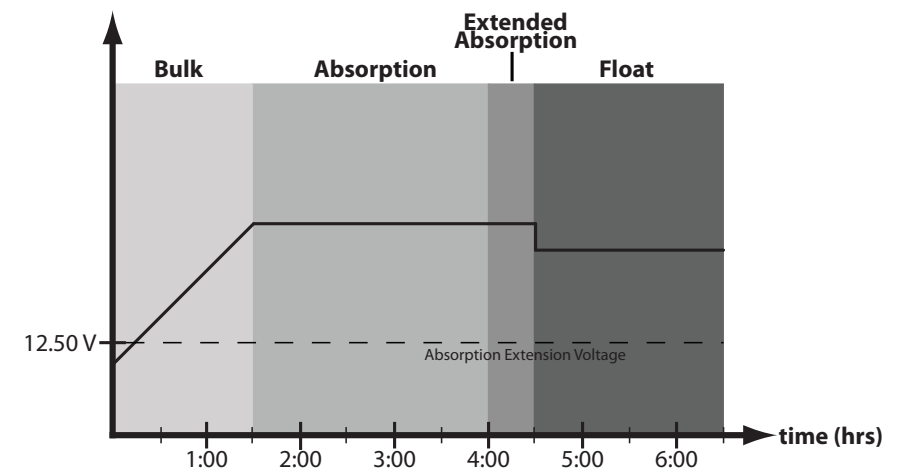

Figure 4-3. Absorption Extension Charging Profile

If battery voltage discharges below 12.50 volts (25.00 volts @ 24V) the previous night, Absorption charging will be extended on the next charge cycle as shown in figure 4-3 above. Thirty minutes will be added to the normal Absorption duration.

### Float Time-out

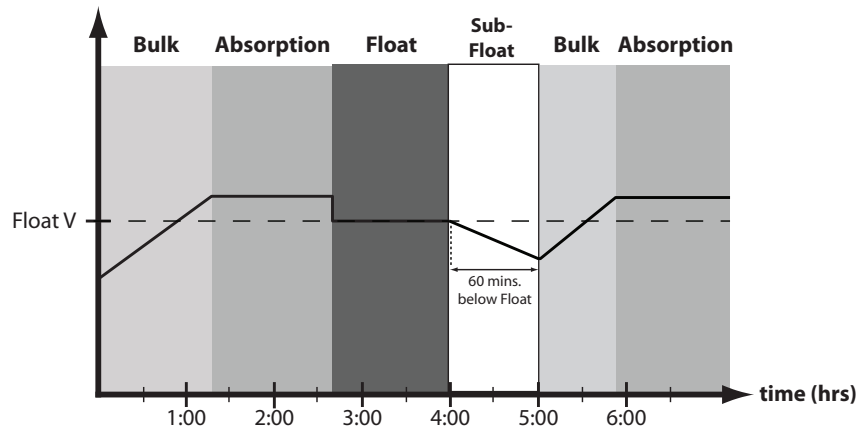

Figure 4-4. Float Exit Time-out Charging Profile

After entering Float stage, the controller will only exit Float if the battery voltage remains below Float voltage for sixty cumulative minutes. In figure 4-4, a system load turns on at 3:30 hrs when the controller is in Float stage, runs for one hour, and turns off at 4:30 hrs. The load current draw is larger than the charge current, causing battery voltage to drop below Float voltage for sixty minutes. After the load runs for sixty minutes, the time-out causes the controller to return to Bulk charging, and then Absorption stage again. In this example, a load runs continuously for sixty min. However, because the Float exit timer is cumulative, multiple momentary load events that pull the battery voltage below Float voltage for a combined sixty minutes duration will also force an exit from Float stage.

### Float Cancel Voltage

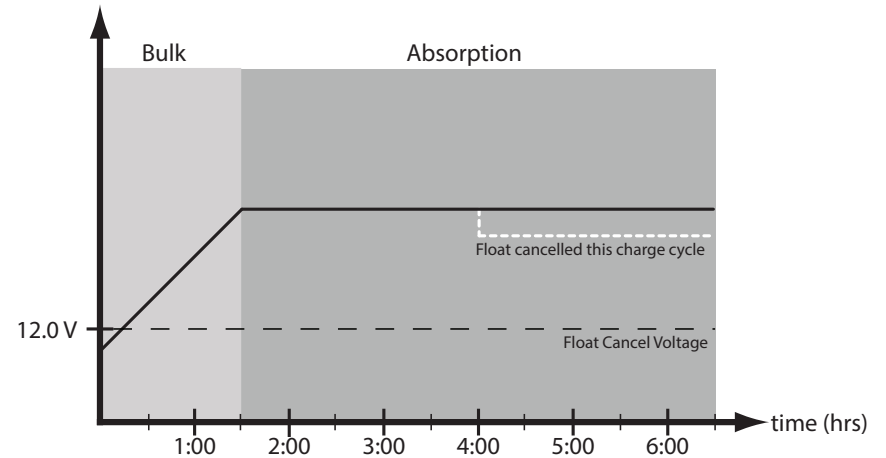

Figure 4.5. Float Cancellation Charging Profile

If the battery bank discharges below 12.10 volts (24.20 volts @ 24 V) the previous night, Float charging stage will be cancelled for the next charge cycle. Figure 4-5 above, illustrates this concept. At 0:00 hrs (dawn), battery voltage is below the Float Cancel threshold voltage. The diagram shows where Float stage would have occurred if Float was not canceled.

## Equalize Time-out

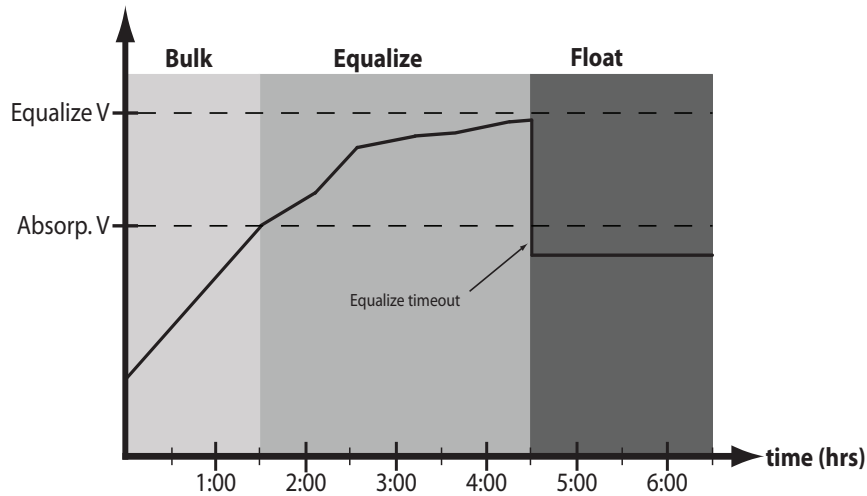

Figure 4.6. Equalize Time-out Charging Profile

The charging profile in figure 4-6 above, shows an *Equalize Time-out* event. The time-out timer begins as soon as battery voltage exceeds the Absorption voltage set-point. If there is insufficient charging current or system loads are too large, the battery voltage may not reach the Equalize set-point. Equalize Time-out is a safety feature that prevents high battery voltage for extended periods of time which may damage the battery.

## 4.3 Load Control Information

The primary purpose of the load control function is to disconnect system loads when the battery has discharged to a low state of charge, and reconnect system loads when the battery is sufficiently recharged. System loads may be lights, DC appliances, or other electronic devices. The total current draw of all loads must not exceed the ProStar MPPT 25 or 30 Amp maximum load rating.



### **CAUTION: Equipment Damage**

Do not wire any AC inverter to the load terminals of the ProStar MPPT. Damage to the load control circuit may result. An inverter should be wired to the battery. If there is a possibility that any other load will sometimes exceed the ProStar MPPT's maximum voltage or current limits, the device should be wired directly to the battery or battery bank. If load control is required, contact Morningstar Tech Support for assistance.



### **PRUDENCE : Dommages matériels**

Ne pas raccorder n'importe quel convertisseur aux bornes de la ProStar MPPT. Pourrait endommager le circuit de commande de charge. S'il y a une possibilité que n'importe quelle autre charge dépassera parfois la tension maximale de la Prostar MPPT ou limites de courant, l'appareil doit être câblé directement sur la batterie ou la batterie. Si le régulateur de charge est nécessaire, contacter le Support technique de Morningstar d'assistance.

### **Current Compensation:**

All LVD and LVR set-points are current compensated. Under load, the battery voltage will sag in proportion to the current draw of the load. A short-term large load could cause a premature LVD without the current compensation feature. LVD and LVR set-points are adjusted lower per the following table.

System Voltage	Current Compensation
12 Volt	-20 mV per amp of load
24 Volt	-40 mV per amp of load

Table 4-3. Current Compensation Values

### LVD Warning:

As the battery discharges, the Battery Status LEDs will transition from green to yellow and then from yellow to flashing red. The flashing red indication is a warning that a low voltage disconnect (LVD) event will occur soon.

The amount of time between a green SOC indication and load disconnect will depend on many factors including:

- rate of discharge (amount of load draw)
- capacity of the battery
- health of the battery
- LVD set-point

If the battery discharges to the LVD set-point the load will disconnect and a solid red Battery Status LED indication will be displayed.

### General Load Control Notes:

Do not wire multiple ProStar MPPT load outputs together in parallel to power DC loads with a current draw greater than 25 or 30A, depending on the ProStar MPPT model in use. Equal current sharing cannot be assured and an over-load condition will likely occur on one or more controllers.

Exercise caution when connecting loads with specific polarity to a live load circuit. A reverse polarity connection may damage the load. Always double check load connections before applying power.

## 4.4 LED Indications

### KEY:

G = green

Y = yellow

R = red

G - Y - R = flashing sequentially

G / Y = flashing together

G / Y - R = G and Y flashing together, alternating with R flash

### 4.4.1. Power-up

Normal power-up: Status LED flashes **G**, then SOC LEDs flash **G - Y - R**, sequentially, then SOC LEDs will indicate battery charge status with one or two lit battery status LEDs.

Failed bootload: Status LED flashes **G**, then SOC LEDs flash **G - Y** and stop on solid **Y**.

### 4.4.2 Status LED

The Status LED indicates charging status and any existing solar input error conditions. The Status LED is on when charging during the day and off at night. The Status LED will flash red whenever an error condition(s) exists. Table 4.4 lists the Status LED indications.

Color	Indication	Operating State
None	Off (with heart-beat <sup>1</sup> )	Night
Green	On Solid (with heart-beat <sup>2</sup> )	Charging
Red	Flashing	Error
Red	On Solid (with heart-beat <sup>2</sup> )	Critical Error

<sup>1</sup> heartbeat indication flickers the Status LED on briefly every 5 seconds

<sup>2</sup> heartbeat indication flickers the Status LED off briefly every 5 seconds

Table 4.4. Status LED Definitions

## NOTES:

- 1) R flashing is generally a user addressable fault / error
- 2) R charging status LED ON with heartbeat blink OFF every 5 secs is a critical fault that generally requires service. See, "Solid Charging Status LED with Self-test (R-Y-G) SOC Faults", in Section 5.1.

### 4.4.3 State-of-Charge LEDs

Battery SOC LED Indications are shown in Table 4-5 below:

Condition	Indication
Absorption	<b>G</b> flash - every sec
Float	<b>G</b> flash - every 2 secs
Start EQ (push-button)	[ <b>G</b> / <b>Y</b> / <b>R</b> ] x2 - <b>G</b> - <b>G</b>
Stop EQ (push-button)	[ <b>G</b> / <b>Y</b> / <b>R</b> ] x2 - <b>R</b> - <b>R</b>
Equalize	<b>G</b> flash - 2 / sec
SOC > 13.5V	<b>G</b> solid
13.5V > SOC > 13.0V	<b>G</b> / <b>Y</b> solid
13.0V > SOC > 12.5V	<b>Y</b> solid
SOC < 12.5V	<b>Y</b> / <b>R</b> solid
Low voltage disconnect warning	<b>R</b> flash - every sec
Low voltage disconnect	<b>R</b> solid

Table 4.5. Battery SOC LED Indications

### 4.5 Push-Button Use in Non-Metered Version

The version of the ProStar MPPT without meter display features a push-button that operates as follows depending on the DIP Switch 1 setting:

#### Normal Mode (DIP 1 OFF)

- Regardless of the DIP 7 setting, press and hold the push-button for 5 seconds to initiate or stop an Equalization (EQ).

#### Lighting Control Mode (DIP 1 ON)

A quick press of the push-button will conduct a ten minute lighting test. A lighting test is used to verify correct wiring in the load circuit and /or verify that the lighting components are operational. The lighting test will override LVD for ten minutes - the override duration is not programmable.

- Press and hold the push-button for five seconds to initiate or stop an Equalization (EQ).

#### Reset PS-MPPT to Factory Settings

To restore factory settings: Disconnect PV; disconnect battery power; press and hold down the push-button; re-start the PS-MPPT by connecting the battery; keep the push-button depressed for 3-5 secs, until the battery LEDs start to cycle R-Y-G.

A Custom Edit Settings fault will occur. See Section 5 for details. The unit will need to be re-powered to resume normal operation.

### 4.6 Alarms

#### Solar Overload

No LED indication. The ProStar MPPT will limit battery current to the 25 or 40 amp maximum rating. An over-sized solar array will not operate at peak power. The solar array should be less than the ProStar MPPT nominal max. input power rating for optimal performance. See Section 7.0 - Technical Specifications for more information.

#### High Temperature Current Limit

The ProStar MPPT will limit the solar input current if the heatsink temperature exceeds safe limits. Solar charge current will be tapered back (to 0 amps if needed) to reduce the heatsink temperature. The Appendix B de-rating graphs indicate maximum ambient temperatures at which the ProStar MPPT will operate with full-rated current; as indicated in each graph, maximum ambient temperature depends on array input voltage. Actual de-rating

temperatures lower than specified in the graphs indicate insufficient airflow. Maximum charging current depends on many factors, and good ventilation can greatly reduce the amount of de-rating. If the controller frequently reports this alarm condition, corrective action should be taken to provide better air flow, or to move the controller to a cooler location.

### High Input Voltage Current Limit

The ProStar MPPT will limit the solar input current as the solar array Voc approaches the maximum input voltage rating. The array Voc should never exceed the 120 volt maximum input voltage - see the array voltage de-rating graph in Appendix.

### Current Limit

The array power exceeds the rating of the controller. This alarm indicates that the ProStar MPPT is limiting battery current to the maximum current rating.

### RTS Open

The Remote Temperature Sensor is not connected to the controller. Use of the RTS is recommended for proper battery charging.

### Heatsink Temperature Sensor Open / Shorted

The heatsink temperature sensor is damaged. Return the controller to an authorized Morningstar dealer for service.

### Battery Sense Out of Range / Disconnected (only alarm with LED indications)

Error status LED: Flashing red. Battery status LEDs: R/Y - G/Y sequencing. A battery sense wire is disconnected. Inspect the battery sense connections. This alarm is set when the voltage at the battery sense terminals differs by more than five volts from the voltage at the battery terminals.

### Uncalibrated

The controller was not factory calibrated. Return the controller to an authorized Morningstar dealer for service.

## 4.7 Custom Settings

### 4.7.1 Programming with the Meter Display

The ProStar MPPT is available in metered and non-metered versions. The metered model allows:

- Custom programming, including lighting programs and low battery temperature foldback, directly from the unit.
- Extensive settings adjustment and information as shown partially in Figure 4-7 below:

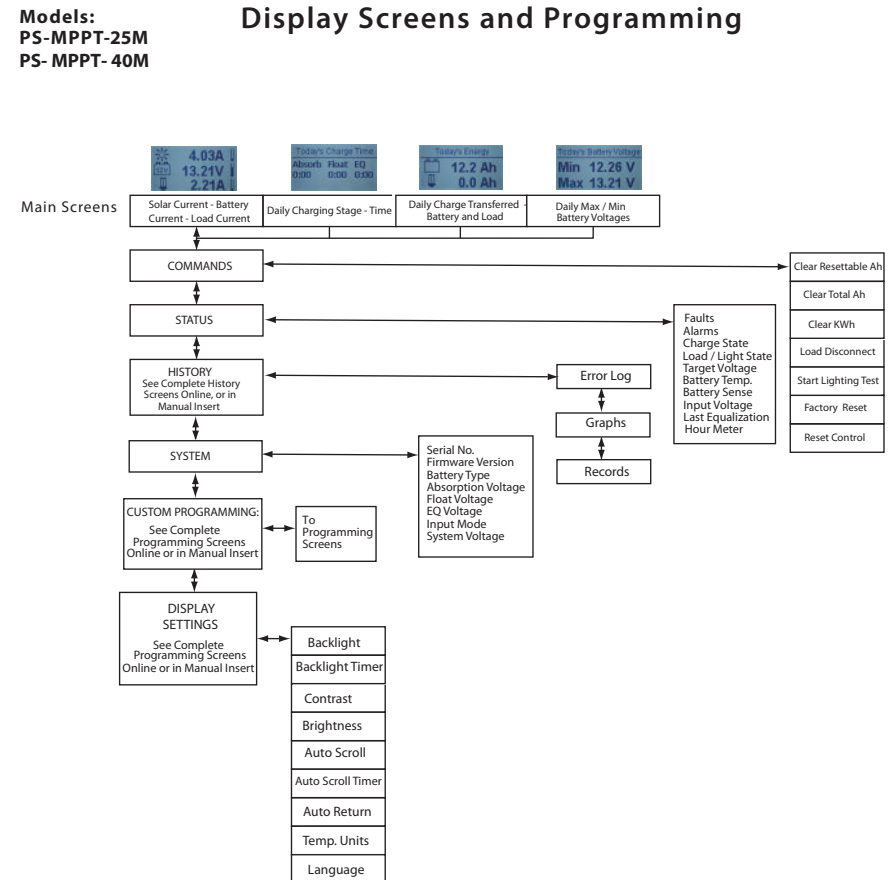

Figure 4-7. Simplified Meter Map. For metered models, see the included complete meter map insert, also available in the ProStar MPPT support documents at:

[www.morningstarcorp.com](http://www.morningstarcorp.com)



## 4.7.2 Programming in MSView

Beyond the preset DIP switch options, the ProStar MPPT's charging profile and all other settings are customizable using MSView PC software available at:

[www.morningstarcorp.com](http://www.morningstarcorp.com)



**WARNING:** *Risk Of Electrical Shock.*

*Hazardous voltage is present at the Meterbus communications port. Use 150V rated, 4 or 6 conductor UL listed telephone cable.*



**AVERTISSEMENT:** *Risque de choc électrique.*

*Tension dangereuse est présente dans le port de communication de transfert. Utilisez 150V évalué, 4 ou 6 conducteurs câble de téléphone répertorié UL.*

With a connection to a PC, and to the RJ-11 port of the PS-MPPT, the MSView ProStar MPPT Set-up Wizard is capable of editing all charging and lighting parameters, for upload to the controller. The Set-up Wizard, and topics within the Help tab describe programming procedures in detail.

All aspects of connection, programming and communications are covered in the Product Connectivity Manual:

[www.morningstarcorp.com](http://www.morningstarcorp.com)

Communications accessories / adapters are housed in the optional Wire Box for ProStar MPPT.

## 4.7.3 Meter Display Operation

### 4.7.3.1 Directional Key Use and Operation / Navigating the Meter Map

The ProStar MPPT's meter map consists of two main axes: The horizontal top level daily monitoring screens, and the vertical Main Menu stacked screens. The four lighted triangular directional control keys allow movement to reach any desired point on the meter map. A lit key indicates

a valid direction in the map. The current location is indicated on the display with a column heading, and a bold descriptor.

### 4.7.3.2 Adjusting the Meter Display

The display setting options, as shown in Figure 4-7, are adjustable by using the directional keys to locate and edit a desired setting or variable.

### 4.7.4 Using the Meter Display to Program Charging Set-points, Load Control, Communications, and Advanced Settings

Refer to the complete meter map insert for metered PS-MPPTs. From a top level monitoring screens, scroll down to the Main Menu - "Custom Programming" - screen. Select the desired category, and edit the variable or settings as instructed in the meter display. Note that charging set-points should be entered as if for a 12V system - DIP switches 2 and 3 settings prompt the controller to multiply if necessary. **TIP:** Using the meter, Float and EQ stages can be disabled by setting these voltages to 0V.

The Load Control category includes Normal (load disconnect) and Lighting programming. The Advanced Settings category includes more optional charging, MPPT, and load control settings.

**NOTE:** Without DIPs 4,5,6 ON (up), only COM address settings options will appear in the meter map. To view and program custom settings via the meter display, DIPs 4,5,6 must be in the ON (up) position.

### 4.7.5 Lighting Control / Programming Overview

The ProStar MPPT display has extensive lighting load programmability.

With DIP switch 1 ON (up), a dusk-dawn lighting program is enabled, if lighting timing hasn't been programmed in MSView or using the meter; with DIP 1, 4, 5, 6 ON, and the unit programmed, custom timing will be in effect.

With DIP 1 OFF (down), all lighting control functions are disabled.

Using either MSView or the meter display, four channels are available for setting timers that can work separately, or in combination. See Section 4.7.6 - Lighting Programming Using Meter Display - for more details.

#### 4.7.6 Lighting Programming Using the Meter Display

Lighting programming capabilities are accessible with the meter via Custom Programming->Load Control->Lighting. Lighting settings editing is done via on-screen instructions.

- The Summary provides a graphical representation of the complete lighting configuration
- LVD / LVR can be specified for use when a lighting program is in operation
- Sunrise and Sunset Threshold settings allow the adjustment of percentages of the maximum seen solar array voltage for triggering day and night events
- There are four channels, each having two timers, which can be used independently, or in combination.
- Events and actions are used as references and controls. An event is one of eight points in a day e.g. sunrise or midnight. Each event can be edited to specify a time offset to trigger an action, which can be, "Do Nothing", "Lights On", or "Lights Off"
- The combination setting of each channel will specify whether the actions and events of each timer will function: not at all (no combination); when both timers' settings match (AND); for either timers' settings (OR)

#### 4.7.7 Low Temperature Foldback

The ProStar MPPT has a Low Temperature Foldback option which can be used to protect lithium batteries from being charged in cold conditions. Custom settings defining the bounds of charge current reduction due to low battery temperature can be programming in MSView, or with the Advanced Custom Settings options with the display interface.

Advanced Custom Settings options are available with ProStar MPPT built-in meter models (PS-MPPT-25M and PS-MPPT-40M).

The High Limit defines the lowest temperature at which the controller will deliver 100% of the controller's rated output charging current. The Low Limit defines the temperature at which the controller will stop providing battery charging current. The charge current is tapered linearly from the High Limit to the Low Limit.

**NOTE:** Local meter display setup required for Low Limit < 1° Celsius.

## 4.8 Inspection and Maintenance

Table 4-6 below lists the recommended maintenance schedule to keep your ProStar MPPT performing optimally.



**WARNING:** Risk Of Electrical Shock.

*No power or accessory terminals are electrically isolated from dc input, and may be energized with hazardous solar voltage. Under certain fault conditions, battery could become over-charged. Test between all terminals and ground before touching.*



**AVERTISSEMENT:** Risque De Choc Électrique.

*Non alimentation ou aux bornes d'accessoires sont isolés électriquement de l'entrée de c.C et doit être alimentés à une tension dangereuse solaire. Sous certaines conditions de défaillance, la batterie pourrait devenir trop chargée. Test entre toutes les bornes et la masse avant de toucher.*



**WARNING:** Shock Hazard

*Disconnect all power sources to the controller before removing the wiring box cover. Never remove the cover when voltage exists on the ProStar MPPT power connections.*



**AVERTISSEMENT:** Risque de décharge électrique

*Déconnecter toutes les sources d'alimentation pour le contrôleur avant d'enlever le couvercle de boîte de connexion. N'enlevez jamais le couvercle lorsque tension existe sur les connexions d'alimentation ProStar MPPT.*

Schedule	Maintenance Items
2 weeks after installation	Re-tighten power terminal connections to specified torque values.
3 months after installation	Re-tighten power terminal connections to specified torque values.
Monthly or After Each Equalization	<p>Inspect the battery bank. Look for cracked or bulging cases, and corroded terminals.</p> <p>For wet cell (flooded type) batteries, make sure the water level is correct. Wet cell water levels should be checked monthly or according to the manufacturer's recommendations.</p>
Annually	<p>Clean the heatsink fins with a clean, dry rag.</p> <p>Inspect all wiring for damage or fraying.</p> <p>Inspect for nesting insects.</p> <p>Re-tighten all wiring terminal connections to specified torque values.</p> <p>Inspect the system earth grounding for all components. Verify all grounding conductors are appropriately secured to earth ground.</p>

Table 4-6. Maintenance Schedule

## 5.0 TROUBLESHOOTING



**WARNING: RISK OF ELECTRICAL SHOCK.**

*NO POWER OR ACCESSORY TERMINALS ARE ELECTRICALLY ISOLATED FROM DC INPUT, AND MAY BE ENERGIZED WITH HAZARDOUS SOLAR VOLTAGE. UNDER CERTAIN FAULT CONDITIONS, BATTERY COULD BECOME OVERCHARGED. TEST BETWEEN ALL TERMINALS AND GROUND BEFORE TOUCHING.*



**AVERTISSEMENT: RISQUE DE CHOC ÉLECTRIQUE.**

*NON ALIMENTATION OU AUX BORNES D'ACCESSOIRES SONT ISOLÉS ÉLECTRIQUEMENT DE L'ENTRÉE DE C.C ET DOIT ÊTRE ALIMENTÉS À UNE TENSION DANGEREUSE SOLAIRE. SOUS CERTAINES CONDITIONS DE DÉFAILLANCE, LA BATTERIE POURRAIT DEVENIR TROP CHARGÉE. TEST ENTRE TOUTES LES BORNES ET LA MASSE AVANT DE TOUCHER.*



**WARNING: Shock Hazard**

*A means of disconnecting all power supply poles must be provided. These disconnects must be incorporated in the fixed wiring. Open all power source disconnects before removing controller wiring cover, or accessing wiring.*



**AVERTISSEMENT: Risque de décharge électrique**

*Un moyen de déconnexion de tous les poteaux d'alimentation doit être fourni. Ceux-ci se déconnecte doit être intégrée dans le câblage fixe. Ouvrir que toutes les source d'énergie se déconnecte avant de retirer le couvercle de la contrôleur, ou accès au câblage.*

### 5.1 LED Fault Indications

#### Load Over-current

Error Status LED: Flashing red. Battery status LEDs: R/Y-G sequencing. If the load current exceeds the maximum load current rating, the ProStar MPPT will disconnect the load. The greater the overload the faster the load will be

disconnected. A small overload could take a few minutes to disconnect. The ProStar MPPT will attempt to reconnect the load two (2) times. Each attempt is approximately 10 seconds apart. If the overload remains after two (2) attempts, the load will remain disconnected until power is removed and re-applied.

### **Solar Short Circuit**

Charging Status LED: OFF. Solar input power wires are short-circuited. Charging automatically resumes when the short is cleared.

### **Battery Reverse Polarity**

No LED indication, the unit is not powered. No damage to the controller will result. Correct the mis-wire to resume normal operation.

### **Load Short Circuit**

Error status LED: Flashing red. Battery status LEDs: R/G-Y sequencing. Fully protected against load wiring short-circuits. After two (2) automatic load reconnect attempts (10 seconds between each attempt) the ProStar MPPT will wait, and then automatically reconnect the load, once the short is cleared.

### **High Solar Voltage Disconnect**

Charging Status LED: R flashing. No battery status errors. If the solar input open-circuit voltage (Voc) exceeds the 120 Volt maximum rating, the array will remain disconnected until the Voc falls safely below the maximum rating.

### **Remote Temperature Sensor (RTS)**

Error status LED: Flashing red. Battery status LEDs: R/Y - G/Y sequencing. A bad RTS connection or a severed RTS wire has disconnected the temperature sensor during charging. Charging automatically resumes when the problem is fixed. To resume operation without an RTS, disconnect all power to the ProStar MPPT and then reconnect. If the controller is re-started with the failure still present, the controller may not detect that the RTS is connected, and the LEDs will not indicate a fault.

A metered model, an RM-1 meter, or MSView PC software, can be used to determine if the RTS is working properly.

### **Solar-Battery High Voltage Disconnect (HVD)**

Error status LED: Flashing red. Battery status LEDs: R-G sequencing. This fault is set when battery voltage is above normal operating limits. The controller will disconnect the solar input and set a Solar High Voltage Disconnect fault. This fault is commonly caused by other charging sources in the system, charging the battery above the ProStar MPPT regulation voltage. Recovery occurs at HVD re-connect threshold, and the fault will clear automatically.

### **Load High Voltage disconnect (HVD) - disabled by default**

Error status LED: None. Battery status LEDs: R-G sequencing. This fault is set when battery voltage is above normal operating limits. The controller will disconnect the load output and set a Load High Voltage Disconnect fault. This fault is designed to protect sensitive loads from excessive voltage. Recovery occurs at HVD re-connect threshold, if programmed, and the fault will clear automatically.

### **High Heatsink Temperature**

Error status LED: Flashing red. Battery status LEDs: R-Y sequencing. The heatsink temperature has exceeded safe limits and the load is disconnected. The load will automatically reconnect when the heatsink cools to a safe temperature.

### **Battery Over-current**

Error status LED: Flashing red. Battery status LEDs: R/Y-G sequencing. While rare, if battery current exceeds approximately 130% of the controller's output current rating, this fault can occur. The fault is generally related to fast, large battery voltage transients (connecting a very heavy or capacitive load like an inverter) that are faster

than the controller can regulate, and it shuts off to protect the circuitry. The controller will automatically re-start in 10 seconds.

### Settings (DIP) Switch Changed

Error status LED: Flashing red. Battery status LEDs: R-Y-G sequencing. If a settings switch is changed while there is power to the controller, the LEDs will begin sequencing and the solar input will disconnect. The controller must be re-started to clear the fault and begin operation with the new settings.

### Custom Settings Edit

Error status LED: Flashing red. Battery status LEDs: R-Y-G sequencing. A value has been modified in custom settings memory. The controller will stop charging and indicate a fault condition. After all settings have been modified, the controller must be reset by removing and then restoring power to the controller. The new programmed settings will be used after the power reset.

### Firmware Update Failure

The firmware update was not successfully programmed. The controller will not indicate the full power-up LED sequence of G-Y-R when power to the controller is reset. Instead, the controller will display green, and then stop on yellow. The yellow LED will continue to be lit and the controller will not complete start up or begin charging.

Re-try the firmware update. The firmware must be successfully loaded before the controller will start up.

### SOLID CHARGING STATUS LED with SELF-TEST (R-Y-G) SOC FAULTS

Verify that nothing has been mis-wired. If not, the error is likely critical. Contact an authorized Morningstar dealer for support.

Fault	Charging Status LED	Battery SOC LEDs
PV FET Short	Solid red	R-Y-G sequencing
Load FET Short	Solid red	R-Y-G sequencing
Load FET Open	Solid red	R-Y-G sequencing
Damaged local temperature sensor	Solid red (only if RTS is invalid)	R-Y-G sequencing
Damaged heatsink temperature sensor	Solid red	R-Y-G sequencing
Software	Solid red	R-Y-G sequencing

### RE-SETTABLE SELF-TEST (R-Y-G) SOC FAULTS

Fault		Battery SOC LEDs
Custom Settings Edit	-	R-Y-G sequencing
DIP Switch Change	-	R-Y-G sequencing

## 5.2 Battery Charging and Performance Issues

### Problem:

No LED indications, controller does not appear to be powered

### Solution:

With a multi-meter, check the voltage at the battery terminals on the ProStar MPPT. Battery voltage must be 10 vdc or greater. If the voltage on the battery terminals of the controller is between 10 and 35 vdc, and no LEDs are lit, contact your authorized Morningstar dealer for service. If no voltage is measured, check wiring connections, fuses, and breakers.

### Problem:

The ProStar MPPT is not charging the battery.

### Solution:

Check the three (3) battery SOC LEDs. If they are flashing in a sequence, see Section 4.5 LED indications of this manual to determine the cause. A metered model, an RM-1 meter, or MSView PC software will display active faults and alarms.

If the LED indications are normal, check the fuses, breakers, and wiring connections in the power source wiring. With a multi-meter, check the array voltage directly at the ProStar MPPT solar input terminals. Input voltage must be greater than battery voltage before charging will begin.

### Problem:

Controller makes buzzing and humming noises.

### Solution:

No action is required. This is expected due to magnetic resonance and circuit switching.

If troubleshooting does not correct the problem, please refer to Morningstar's Warranty Claim Procedure in Section 6.

## 6.0 WARRANTY & POLICIES

### WARRANTY

LIMITED WARRANTY - Morningstar Solar Controllers and Inverters

Integrated Series products, SureSine Family (Gen 2) inverters and other Morningstar *Professional Series*<sup>TM</sup> products, except the SureSine<sup>TM</sup>-300 Classic (Gen 1) inverter, are warrantied to be free from defects in materials and workmanship for a period of FIVE (5) years from the date of shipment to the original end user. Warranty on replaced units, or field-replaced components, will be limited only to the duration of the original product coverage.

Morningstar *Essentials Series*<sup>TM</sup> products, and SureSine<sup>TM</sup>-300 Classic (Gen 1) inverter, are warrantied to be free from defects in materials and workmanship for a period of TWO (2) years from the date of shipment to the original end user. Warranty on replaced units, or field-replaced components, will be limited only to the duration of the original product coverage.

Morningstar will, at its option, repair or replace any such defective units.

### CLAIM PROCEDURE:

Before requesting warranty service, check the operator's manual, including any troubleshooting section, to verify product failure. To begin the warranty replacement process, contact your authorized Morningstar distributor or dealer for assistance with troubleshooting and, if necessary, obtaining an RMA number.

**An RMA number must be issued by Morningstar prior to return of any unit(s) under this warranty. Required RMA information:**

(A) purchase location - business or company name - and date

(B) full model and serial numbers (SN is 8-digits on unit bar label)

(C) failure behavior, including LED indications

(D) array configuration, panel Pmax, Voc, Vmp, Isc, and nominal battery voltage - these specifications are needed to receive assistance.

(E) multi-meter available (for field troubleshooting)

After the dealer is contacted, and is not able to assist with warranty claim, contact Morningstar Technical support at support@morningstarcorp.com. Please provide proof of date and place of purchase, and all details listed in preceding paragraph.

#### **WARRANTY EXCLUSIONS AND LIMITATIONS:**

This warranty does not apply under the following conditions:

- Damage by accident, negligence, abuse or improper use
- PV or load currents exceeding the ratings of the product
- Unauthorized product modification or attempted repair
- Damage occurring during shipment
- Damage resulting from acts of nature such as lightning, weather extremes, or infestation

THE WARRANTY AND REMEDIES SET FORTH ABOVE ARE EXCLUSIVE AND IN LIEU OF ALL OTHERS, EXPRESS OR IMPLIED. MORNINGSTAR SPECIFICALLY DISCLAIMS ANY AND ALL IMPLIED WARRANTIES, INCLUDING, WITHOUT LIMITATION, WARRANTIES OF MERCHANTABILITY AND FITNESS FOR A PARTICULAR PURPOSE. No Morningstar distributor, agent or employee is authorized to make any modification or extension to this warranty.

MORNINGSTAR IS NOT RESPONSIBLE FOR INCIDENTAL OR CONSEQUENTIAL DAMAGES OF ANY KIND, INCLUDING BUT NOT LIMITED TO LOST PROFITS, DOWN-TIME, GOODWILL OR DAMAGE TO EQUIPMENT OR PROPERTY.

R20-4/23

Morningstar Corporation  
8 Pheasant Run, Newtown, PA 18940 USA  
(215) 321-4457

www.morningstarcorp.com  
support@morningstarcorp.com

# 7.0 TECHNICAL SPECIFICATIONS

PS-MPPT-25 PS-MPPT-40  
PS-MPPT-25M PS-MPPT-40M

## Electrical:

Nominal Battery Voltage All: 12 or 24 Volts  
 Battery Voltage Range All: 10-35 Volts  
 Voltage Accuracy All: 0.1% +/- 50mV  
 Max. Battery Current 25 Amps 40 Amps  
 Max. PV Open-Circuit Voltage All: 120 Volts  
 Load Current Rating 25 Amps 30 Amps  
 Self-Consumption All: ~0.6W (no meter) ~1.0W (w/backlit meter)  
 LED Indications (1) status, (3) battery SOC  
 Transient Surge Protection 4500 watts (solar, battery, load)  
 Conversion Efficiency (peak) All: 97.3%

## Mechanical:

Dimensions:  
 Standard 7.87(W) x 7.62(L) x 2.76(D) in. /  
 20.0(W) x 19.4(L) x 7.0(D) cm  
 Wire Box Option 7.87(W) x 11.22(L) x 3.62(D) in. /  
 20.0 (W) x 28.5 (L) x 9.2(D) cm  
 Weight:  
 Standard Version 3.1 lb /1.4 kg  
 Standard Version with Wire Box 3.4 lb /1.5 kg  
 Wire Size Range:  
 Power Terminals 2.5 - 16 mm<sup>2</sup> / #14 - 6 AWG (up to #2 AWG  
 with Wire Box)  
 Maximum torque 35 in-lb  
 Battery voltage sense and RTS 0.25 - 1.0 mm<sup>2</sup> / #24 - 16 AWG  
 Maximum torque 5 in-lb  
 Knock-outs (Wire Box option only) M20, 1/2", 1" (trade sizes)  
 Enclosure IP20, Type 1

## Battery Charging:

4-Stage Charging: Bulk, Absorption, Float, Equalize  
 Temperature compensation  
 Coefficient: -30mV / 12 volt / °C  
 Temperature compensated  
 set-points: Absorption, Float, Equalize, HVD  
 and HVDR (solar)

## Battery Charging Set-points (@ 25°C):

[multiply voltages by (2) for 24 volt systems]

DIP Switch Settings 4-5-6	Battery Type	Absorp. Stage (volts)	Float Stage (volts)	Equalize Stage (volts)	Absorp. Time (mins)	Equalize Time (mins)	Equalize Timeout (mins)	Equalize Interval (days)
off-off-off	1 - Sealed*	14.00	13.50		150			
off-off-on	2 - Sealed*	14.15	13.50	14.40	150	60	120	28
off-on-off	3 - Sealed*	14.30	13.50	14.60	150	60	120	28
off-on-on	4 - AGM/Flooded	14.40	13.50	15.10	180	120	180	28
on-off-off	5 - Flooded	14.60	13.50	15.30	180	120	180	28
on-off-on	6 - Flooded	14.70	13.50	15.40	180	180	240	28
on-on-off	7 - L-16	15.40	13.40	16.00	180	180	240	14
on-on-on	8 - Custom	Custom	Custom	Custom	Custom	Custom	Custom	Custom

\* "Sealed" battery type includes gel and AGM batteries

## Current Compensation:

12 volt systems -15 mV / A  
 24 volt systems -30 mV / A  
 Compensated set-points LVD

## Load and Solar Control (multiply voltages by (2) for 24 volt systems):

Default values (customizable)

LVD<sup>1</sup> 11.5V  
 LVR<sup>1</sup> 12.6V  
 Instant LVD 10.0V  
 HVD - solar Highest set-point in  
 preset charging profile  
 [+ 0.5V (@ 25°C)]  
 HVD - load<sup>1</sup> Disabled  
 HVDR - solar 13.8V (@ 25°C)  
 HVDR - load<sup>1</sup> Disabled  
 LVD Warning 4 minutes  
 LVD Override - Lighting Test 10 minutes  
 Maximum # LVD overrides No limit unless  
 (not customizable) V\_batt < Instant LVD

<sup>1</sup> Applies to units with Firmware v27 and higher



### Lighting Control (DIP 1 ON):

Lighting Timer Setting                      Dusk-Dawn (default)  
Lighting Test Timer                            10 minutes

### Data & Communications:

Communication Port                            MeterBus  
Comm. Protocols                                Morningstar MeterBus;  
    MODBUS  
Datalogging                                      6-8 months, daily records  
PC Software                                      MSView

### Digital Meter:

Resolution                                        128 x 64  
Viewing Area                                    70mm x 40mm  
Display Color                                    blue on white  
Backlight                                         LED  
Operating Temperature                        -20°C to +60°C  
Storage Temperature                          -30°C to +80°C

### Environmental:

Maximum Operating Altitude                2000 meters  
Ambient Temperature Range:  
  T4 Certified                                 -40°C to +60°C  
  T5 Certified                                 -40°C to +45°C  
Storage Temperature                         -40°C to +80°C  
Humidity                                        100% n.c.  
Tropicalization                                 Conformally coated PCBs;  
    Marine-rated terminals

*For hazardous location-IECEX/ATEX applications, see the addendum - part no. MS-003244-EN - to this manual.*

### Protections

Power-up against any active faults  
Reverse Polarity - battery and array  
Solar Short-Circuit  
High Solar Voltage Disconnect  
High Heatsink Temperature - Current De-rating  
High Heatsink Temperature - Load Disconnect  
Load Short-Circuit  
Load Over-Current  
Heatsink Temperature Limit  
RTS Terminals  
Battery Sense Terminals

## APPENDIX A - Efficiency Graphs

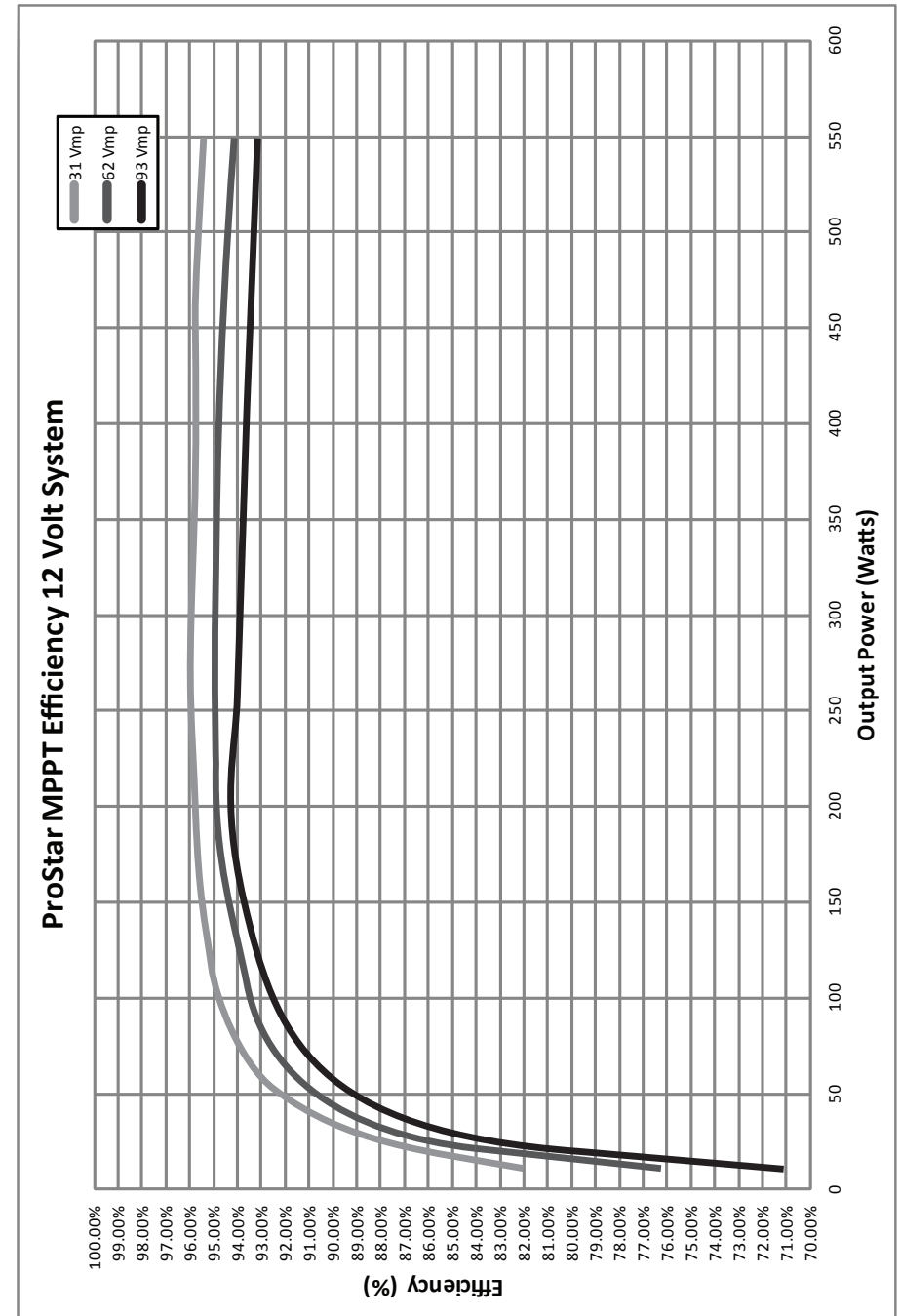

### ProStar MPPT Efficiency 24 Volt System

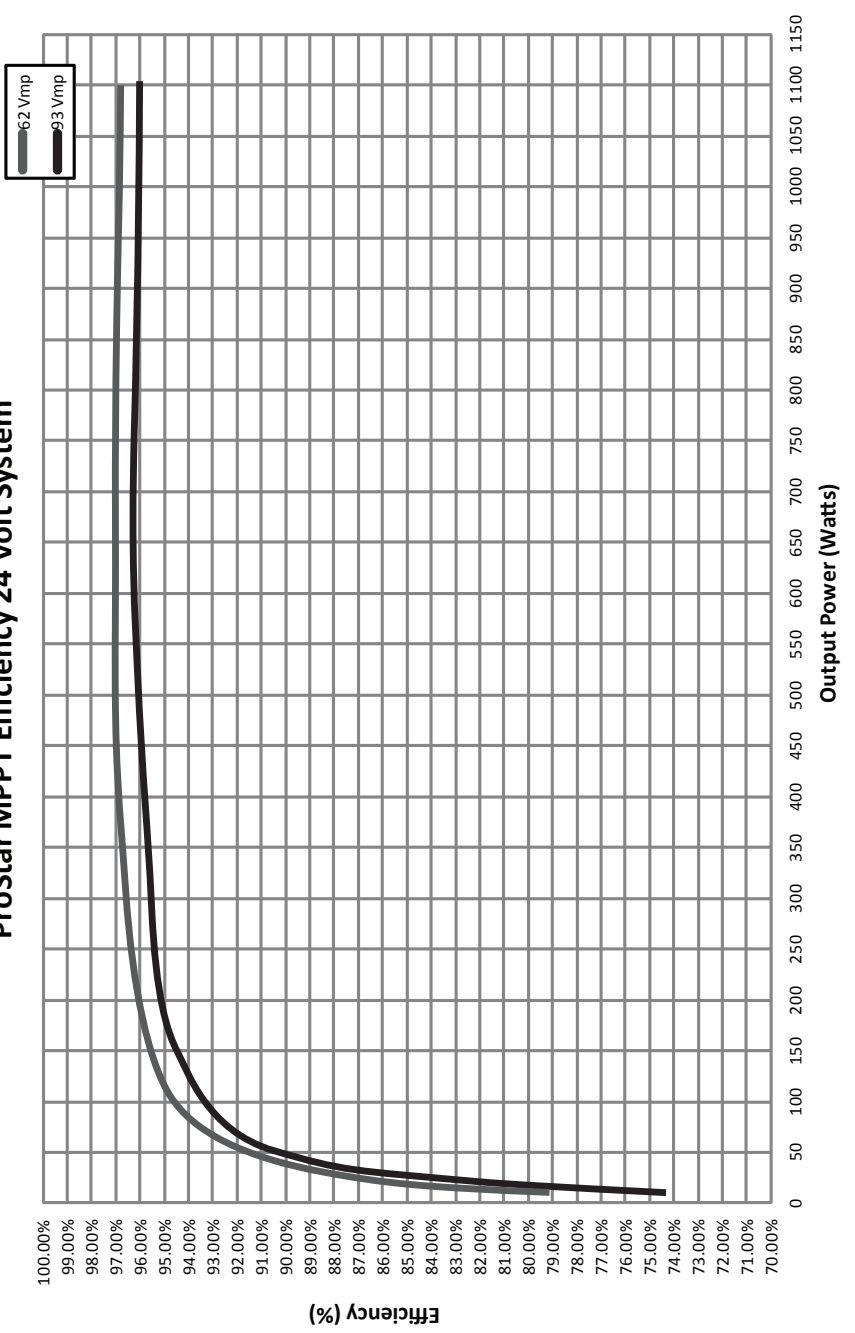

## APPENDIX B - De-rating Graphs

### PS-MPPT 40A Charging Current vs. Array Voltage

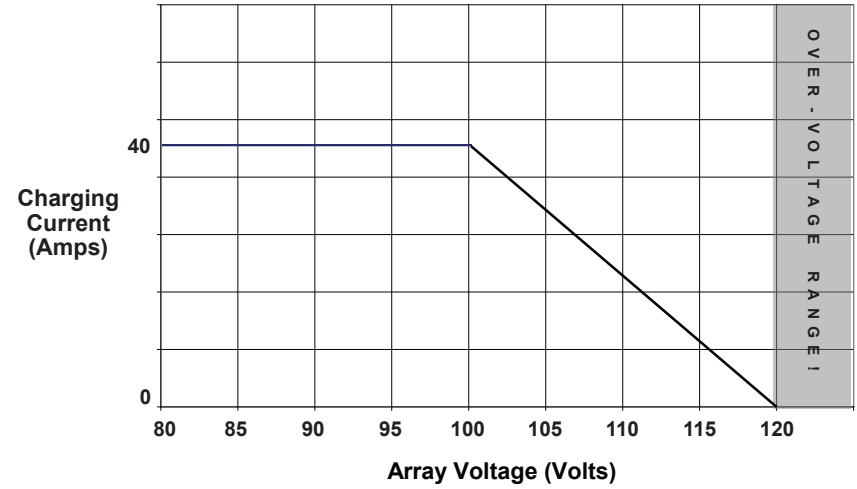

Figure B-1

### PS-MPPT 40 (mounted vertically on wall) Charging Current vs. Ambient Temp.

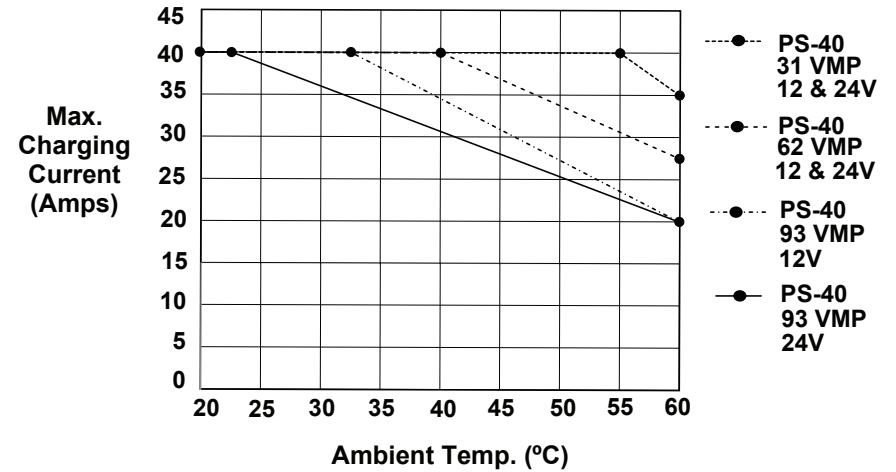

Figure B-2

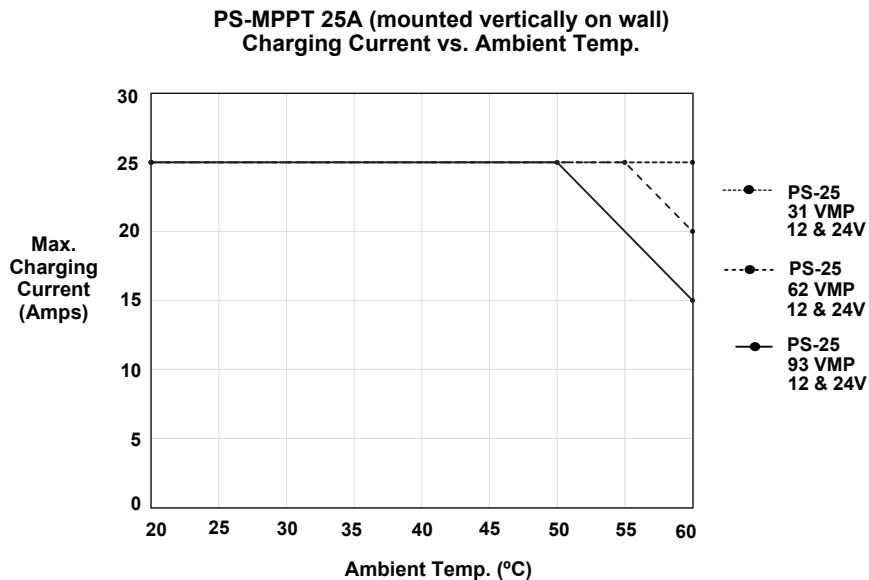

Figure B-3

## APPENDIX C - Wire Sizing

### Minimum Wire Sizing

Wire sizing requirements are based on the ampacity - current-carrying capacity - of conductors. The NEC includes Ampacity Tables which are used to determine the ampacity for a given wire size as indicated in Section 310.15.

ProStar MPPT power terminals are rated for 75°C. When wires with a 90°C temperature rating are used with terminals that have a 75°C temperature rating, wire ampacity at 75°C must be used. This also applies to the temperature ratings of breaker terminals.

Wire ampacity requirements for the battery and PV array circuits are as follows:

Controller battery wire ampacity must be greater than or equal to 125% of maximum continuous current (battery current rating of the controller)

PV array wire ampacity must meet both of the following requirements:

Must be greater than or equal to 156% of PV Array Isc without correction and adjustment factors

Must also be greater than or equal to 125% of PV Array Isc with correction and adjustment factors

Load wire ampacity must be greater than or equal to the load breaker current rating.

Wire ampacity correction and adjustment factors may also be required to account for the following:

- maximum ambient temperature
- temperatures at different parts of the circuit (rooftops or engine rooms for example)
- wire terminal temperature ratings
- multi-conductor cables
- conduit fill and other factors

**Minimum Battery Wire Sizing** (Table C-1) for 75° or 90°C rated stranded copper wire

MODEL	Wire Size in a raceway, cable, or earth (AWG) <sup>1</sup>		Wire Size in free air <sup>2</sup>		Metric Wire Size (mm <sup>2</sup> ) <sup>3</sup>
	30°C	30°-60°C	30°C	30°-45°C	
PS-MPPT 25	10 AWG	8 AWG > 35°C 6 > 55°C	10 AWG	10 AWG	6-10
PS-MPPT 40	8 AWG	6 AWG > 35°C 4 AWG > 45°C	8 AWG	8 AWG	10-18

**NOTES:**

<sup>1</sup> Per NEC 2021 [see NEC Table 310.15(b)(16)], ampacity for not more than three current-carrying conductors in a raceway, cable, or earth (buried)

<sup>2</sup> Per NEC 2021 [see NEC Table 310.15(b)(17)], ampacity for conductors in free air

<sup>3</sup> Estimated. See local code requirements for metric cable sizing

Table C-1. Minimum DC battery wire sizes for 75° or 90°C rated stranded copper wire

**Voltage Drop Tables**

Good system design generally requires large conductor wires that limit voltage drop losses to 2% or less. The tables below provide wire sizing for a maximum of 2% voltage drop. Longer distance wire runs may require significantly larger wire sizes to reduce the voltage drop to an acceptable level.

**ProStar MPPT Voltage Drop Tables**

**2% Voltage Drop Chart (feet) for 75° or 90°C Stranded Copper Wire - 12 Volt System** / Maximum 1-way Distance (feet), 12 Volt System - multiply values by (2) for 24 Volt and by (4) for 48V, system. NOTE: Distances are estimates only and can vary based on temperature, type of wire and other factors.

Wire Size (AWG)	40A	35A	30A	25A	20A	15A	10A
1/0	29.3	33.5	39.0	47.0	59.0	78.0	117.0
1*	23.2	26.5	31.0	37.1	46.0	62.0	77.0
2*	18.4	21.1	24.6	29.5	36.9	49.1	61.0
3*	14.6	16.7	19.5	23.3	29.2	38.9	48.6
4*	11.6	13.3	15.5	18.6	23.2	31.0	38.7
6	7.3	8.3	9.7	11.6	14.6	19.4	24.3
8	4.6	5.3	6.1	7.4	9.2	12.3	15.3
10		3.3	3.8	4.6	5.8	7.7	9.6
12				2.9	3.6	4.8	6.0
14					2.3	3.0	3.8

\* Wire sizes larger than #2 AWG, or #6 AWG (#8 AWG with fine stranded wire) when using the terminal cover, must be terminated at a splicer block located externally to the ProStar MPPT. Use #2 AWG (or smaller) wire to connect the ProStar MPPT to a splicer block.

Table C-2. Maximum one-way circuit distance (feet) for 12 Volt systems, stranded copper, 2% voltage drop

**2% Voltage Drop Chart (meters) for 75° or 90°C Stranded Copper Wire - 12 Volt System /** Maximum 1-way Distance (meters), 12 Volt System - multiply values by (2) for 24 Volt and by (4) for 48V, system. NOTE: Distances are estimates only and can vary based on temperature, type of wire and other factors.

Wire Size (AWG)	40A	35A	30A	25A	20A	15A	10A
70*	11.0	12.6	14.7	17.6	22.0	29.4	44.1
50*	7.6	8.7	10.2	12.2	15.3	20.3	30.5
35*	5.6	6.4	7.5	9.0	11.3	15.0	22.6
25*	4.1	4.6	5.4	6.5	8.1	10.8	16.3
16*	2.6	2.9	3.4	4.1	5.2	6.9	10.3
10	1.6	1.8	2.2	2.6	3.2	4.3	6.5
6		1.1	1.3	1.5	1.9	2.6	3.8
4			0.9	1.0	1.3	1.7	2.6
2.5					0.8	1.1	1.6

\* Wire sizes larger than 35mm<sup>2</sup>, or 16mm<sup>2</sup> (10mm<sup>2</sup> with fine stranded wire) when using the terminal cover, must be terminated at a splicer block located externally to the ProStar MPPT. Use 35mm<sup>2</sup> (or smaller) wire to connect the ProStar MPPT to a splicer block.

Table C-3. Maximum one-way circuit distance (meters) for 12 Volt systems, stranded copper, 2% voltage drop

## Celsius to Fahrenheit Conversions

°Celsius	°Fahrenheit
30	86
35	95
40	104
45	113

Table C-4. Celsius to Fahrenheit Conversions

# PROSTAR MPPT ADDENDUM TO OPERATOR'S MANUAL

FOR CURRENT DETAILED CERTIFICATION LISTINGS, REFER TO:

<https://www.morningstarcorp.com/support/library>

Under, "Type", choose, "Declaration of Conformity (DOC)", to view list of product DOCs.

ProStar MPPT™, MeterBus™ are trademarks of Morningstar Corporation.

MODBUS™ and MODBUS TCP/IP™ are trademarks of Modbus IDA.

©2023 Morningstar Corporation. All rights reserved.

MS-001537 v3.6

## Certifications

---



UL1741 INVERTERS, CONVERTERS, AND CONTROLLERS AND INTERCONNECTION SYSTEM EQUIPMENT FOR USE WITH DISTRIBUTED ENERGY SOURCES, SECOND EDITION, REVISION THROUGH AND INCLUDING SEP 07, 2016

CSA C22.2#107.1-01 POWER CONVERSION EQUIPMENT

UL121201/CSA C22.2 #213 Non-incendive Electrical Equipment for Use in Class I, Division 2 Hazardous (Classified) Locations, Groups A,B,C,D, Temperature Group: T4, T5 (see product manual environmental specifications)

EMC Directives

- Immunity: EN 61000-6-1
- Emissions: EN 61000-6-3  
CISPR 22

Low Voltage Directive:  
IEC/EN 62109-1

## **Hazardous Locations for IECEx/ATEX Applications**

---

IECEX ETL 20.0066X  
ITS20ATEX25933X

IECEX: Ex ec ic IIC TX Gc

ATEX:  II 3G Ex ec ic IIC TX Gc

T4:  $-40^{\circ}\text{C} \leq T_{\text{amb}} \leq +60^{\circ}\text{C}$

T5:  $-40^{\circ}\text{C} \leq T_{\text{amb}} \leq +45^{\circ}\text{C}$

Prostar MPPT must be verified with di-electric strength test specified by the relevant industrial standard.

The equipment must be placed inside an Ex-rated IP 54 enclosure in accordance with IEC 60079 series. A tool is required in order to access the equipment inside the enclosure.

Morningstar Corporation

8 Pheasant Run, Newtown, PA 18940 USA

10611 Iron Bridge Road, Ste. L, Jessup, MD 20794 USA

MS-003244-EN-5