



Model BB5024H

50AH 24V
LiFePO₄ Deep Cycle Battery
Data sheet

Electrical Specification

Voltage	24V
Capacity	50AH
Operating Temperature	-4°F to 135°F (-20°C to 57.2°C)
Efficiency	99%
Self Discharge	2-3% per month
Maximum Series Voltage	48V
Cycles	3K-5K
Built-in BMS	Internal
Resistance	25 mΩ
Usable DoD	100%

Discharging Specification

Max Discharge Current	50A
Peak Discharge Current	100A for 30 Seconds
Surge for Loads over 500A	.5 Seconds
Recommended LVD	21V
BMS Discharge Voltage Cut-Off	20V
Reconnect Voltage	20V
Short Circuit Protection	Yes

Recognized Specification

Certifications	Pending
Shipping Class	UN3480, Class 9

Drawing Specification

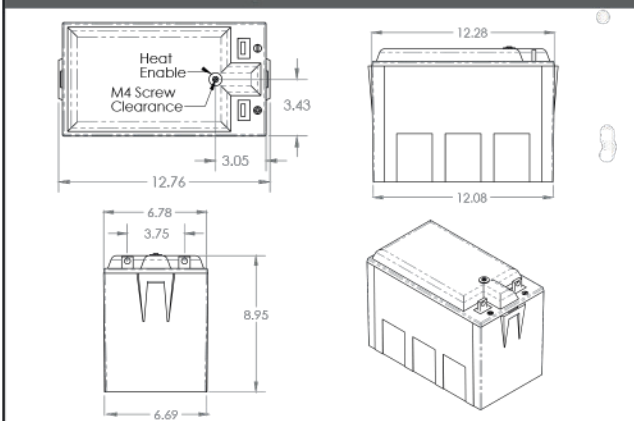

Charging Specification

Recommended Charge Current	.5c
Max Charge Current	25A
Absorption Voltage	28.4V-29.2V
Float Voltage	26.8V-27.6V
Equalization Voltage (if applicable)	28.8V
Absorption Time	15 Minutes per 50AH battery bank
BMS Charge Current Cut-Off	.5C Recommended
Recharge/Rebulk Voltage	26.6V
BMS Cell Balancing Voltage Range	28.4V-29.2V
High BMS Voltage Protection	29.4VDC
Temperature Compensation	No/Disable

Mechanical Specification

Dimensions	12.76"L X 6.86"W X 8.95"H
Weight	31 lbs.
Terminal Type	.25" Brass
Terminal Hole	3/8" hole and 3/8" or 5/16" hardware is suggested
Terminal Torque	9-11 Ft-lb.
Case Material	ABS Fire Rated
Cell Type - Electrolyte	LiFeP04
Sealed and Water Resistant Case	Non-Submersible
Heat enable Terminal	Female M4 Thread

Temperature Specification

Discharge Temperature	-4°F to 135°F (-20°C to 57.2°C)
Charge Temperature	25°F - 135°F
Storage Temperature	-10°F to 140°F (-23°C to 60°C)
BMS High Temperature Cut-Off	>135°F
BMS Reconnect Temperature	<135°F



Model BB5024H

50AH 24V

LiFePO₄ Deep Cycle Battery

Data sheet

Performed Operation Data

.5C Discharge with Temperature Variations

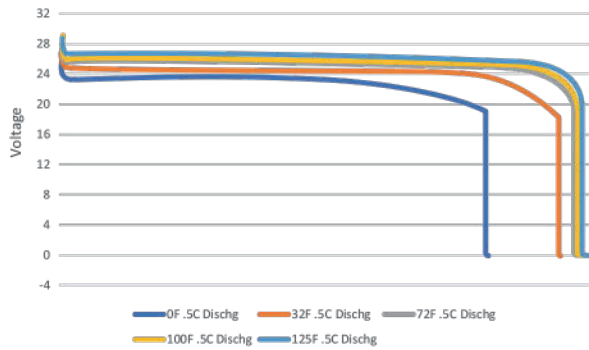

1C Discharge Voltage with Temperature Variations

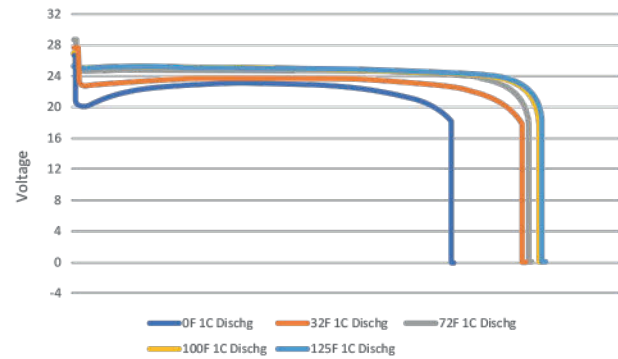

.5C State of Charge with Temperature Variations

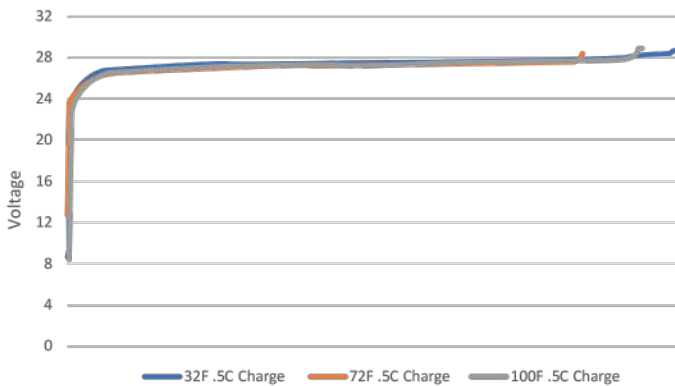

Standard Charge Curve with 3 Stage Charger

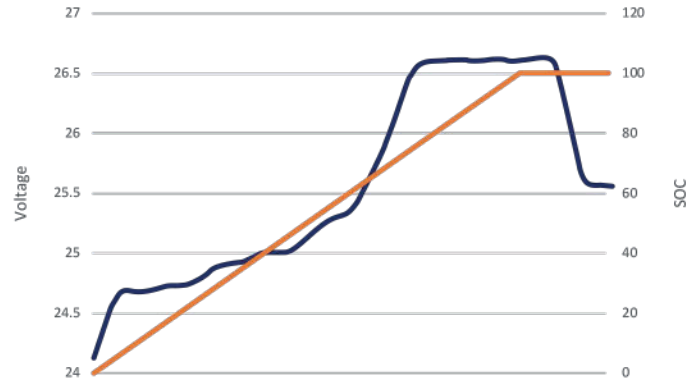

5024H Heater Draw Expected in a 24Hr Period

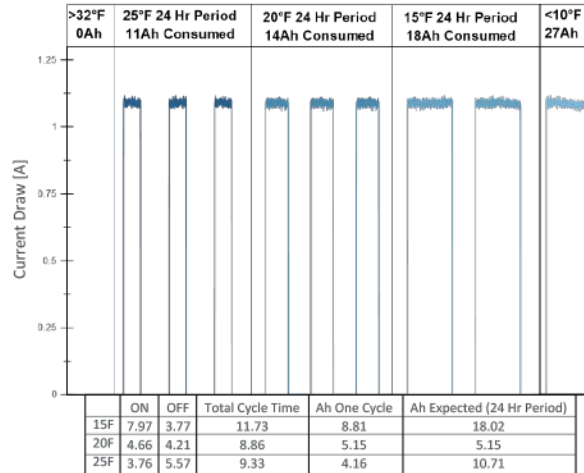
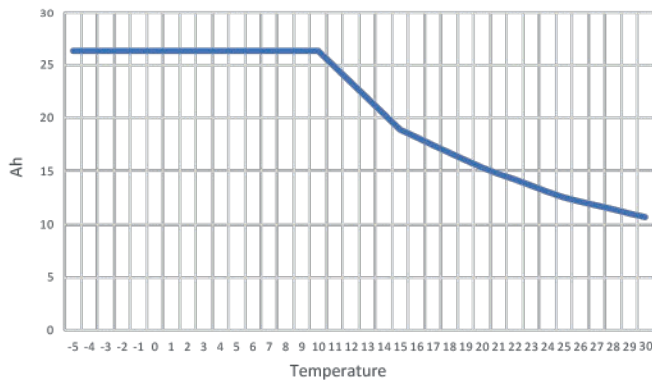

*Note: The storage temperature range is -10°F to 140°F (-23°C to 60°C). We recommend bringing the Battle Born Batteries to a 100% charge and then disconnecting them completely for storage. After six months in storage, your batteries will remain 75 – 80% charged.

Storing batteries in subzero weather (-15°F or more) has the potential to crack the ABS plastic and more importantly could cause a faster loss of capacity, in some cases drastically more than the typical 2 – 4% per month loss.