



8K™ BROCHURE



Modes:
Grid Sell, Off-Grid, Meter Zero,
Time of Use,
& Peak Shaving

RSD/Emergency Stop,
External CT Sensors, Parallel
Comms/Battery Comms,
Auto Gen Start

Battery Agnostic
48V Nominal &
at least 50Ah

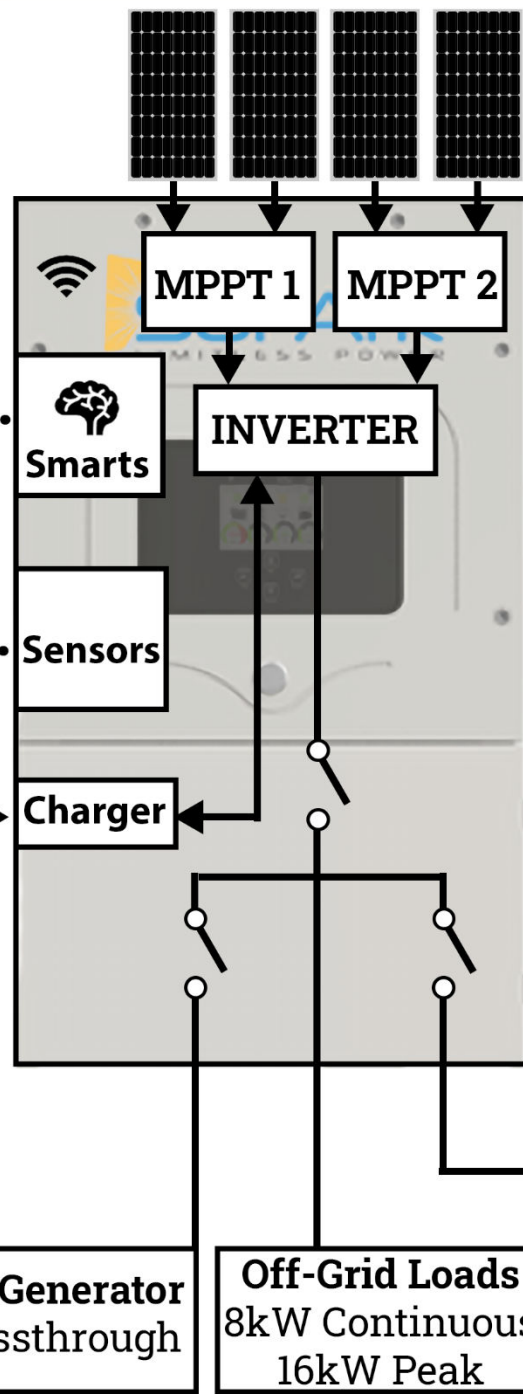

11kW DC Coupling
150V-425V @ 20A
per MPPT

4ms UPS
No-Glitch Transfer

Smart Load
Prioritize
Necessities &
Run Luxuries
With Less

Gen Breaker
Up to 12kW
Generator Input

AC Coupling
9.6kW Output

Grid or Generator
63A Passthrough

Off-Grid Loads
8kW Continuous
16kW Peak



8K[®]



Install Simplicity

You don't have to piece together multiple parts to get basic functions. Ours does it all, does it better, and does it with simplicity.

7 Day/Week Engineering & Customer Support

Sol-Ark beats all competition at customer support. Our engineers assist with all questions, diagnoses, and remote unit management.

We solve virtually any problem without a site visit.

Highest Rated Reviews On Energy Sage

Feature Comparison	Sol-Ark 8K	Tesla Powerwall2 x 2	Generac PWRcell	LG/SolarEdge EnergyHub	Enphase Encharge 10
Install Simplicity	Entire Home Transfer Switch, All-In-One Hybrid, Some Load mgmt.	Entire Home Transfer Switch. No Load mgmt.	Entire Home Transfer Switch, All-In-One Hybrid, 8ch Load mgmt.	Entire Home Transfer Switch. No Load mgmt.	Entire Home Transfer Switch. No Load mgmt.
7 Day Single Support Line For Solar + Storage for both installer and end-user	Yes	No	Yes	No	Yes
Peak Current (Off-Grid) Higher Power = Fewer Support Calls	67A	60 A	50 A	30 A	24.6 A
Continuous PV to AC Power (On-Grid)	8 kW	15.2 kW	7.6 kW	7.6 kW	10-15kW
Continuous Batt Power (On/Off-Grid)	8 kW	10kW	7.6kW	5kW	3.84kW
Battery Life Span	16 Years (LFP) No Cooling Needed	10 Years NMC Must Active Cool	10 Years NMC Must Active Cool	7 Years NMC Only Passive Cooling	16 Years (LFP) No Cooling Needed
Hardware Reliability	20+ Year Design Life, Electronics Isolated from Environment	20+ Year Design Life, Electronics Isolated from Environment	10 Year Life, Electronics Exposed to Humidity & Dust or Clogged Filter	20+ Year Design Life, Electronics Isolated from Environment	20+ Year Design Life, Electronics Isolated from Environment
AC Coupling for Easy Upgrades	Yes	Yes	No	Yes	Yes
Charging Battery from Generators	Yes	No	No	No	No
PV to Batt to AC Efficiency	93%	87%	85%	82%	87%
Fleet Mgmt Tool w/ Remote Setup	Yes	No	Yes	Yes	Yes
Customer Satisfaction Rating / Reviews	5.0 x 82	4.0 x 210	5.0 x 1	3.0 x 19	3.5 x 24