

BATTLE BORN®

Unstoppable Power Solutions

Product Manual and Installation Guide

270 Amp Hour 12 Volt Lithium Battery

Models: BBGC3 / BBGC3H

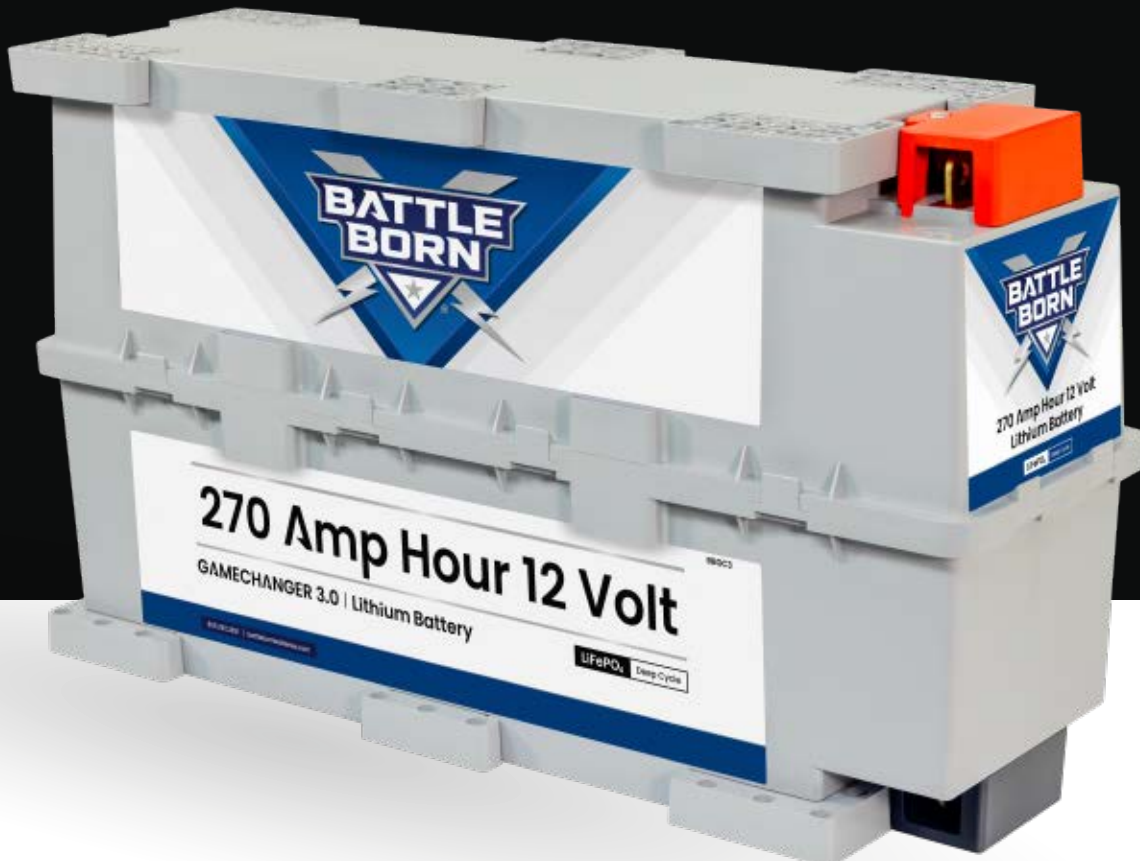

For Technical Support, please contact: 855.292.2831 | info@battlebornbatteries.com

Product Name and Model

- Battle Born 270 Amp Hour 12 Volt Lithium Battery (BBGC3)
- Battle Born 270 Amp Hour 12 Volt Heated Lithium Battery (BBGC3H)

Certifications

	Conforms to UL STD 62133-2 Certified to CSA STD C22.2# 62133-2 Conforms to UL STD 2054
	Class I, Division 2, Group A, B, C, D Ambient Temperature -4F/-20C >Ta < 135F/57.2C Tcode- T3 (200C) Conforms to UL 121201 Certified to CSA C22.2#213
	Conforms to: ANSI/IEC 60529-2020 and CSA No. 60529:16 (R2021)
	



 Caution: Risk of Fire and Burns. Do Not Open, Crush, Heat Above 150°F, or Incinerate. Follow Manufacturer's Instructions.

 ATTENTION, Risque d'incendie et de brûlures. Veuillez ne pas ouvrir, percer, ou exposez à une chaleur égal ou supérieur à 66° C. Ne pas mettre dans le feu. Veuillez suivre les instructions du fabricant.

IEC: 4LFpR26/65-30

Manufacturer Contact Information – Dragonfly Energy

775.622.3448 | info@dragonflyenergy.com | Dragonflyenergy.com

Customer Support – Battle Born

855.292.2831 | info@battlebornbatteries.com | Battlebornbatteries.com

Information About Your System

As soon as you open your product, record the following information and be sure to keep your proof of purchase.

Serial Number: _____

Purchased From: _____

Purchase Date: _____

Welcome to the Battle Born Family!

Thank you for selecting Battle Born Batteries® for your lithium power needs. We appreciate your confidence in our products and are committed to delivering advanced battery systems that meet your energy needs with reliability and performance.

This manual is designed to provide you with essential information for the installation, operation, and maintenance of your battery system. Whether you are a returning customer or using our products for the first time, this guide serves as a valuable resource to help you get the most from your investment.

If you have any questions or require further assistance, please don't hesitate to contact our technical support team.

Table of Contents

Product Overview	4
What is in the Box?	8
Battery Safety	10
Installation Guide	13
Properly Charging the Batteries	15
Parallel Batteries Connection	17
Series Batteries Connection	19
Battery Management System (BMS)	21
Additional System Considerations	23
Storage, Maintenance, Recycling & Disposal	26
Warranty, Returns & Shipping	28

For additional information and the latest technical literature, please refer to our website: battlebornbatteries.com



Product Overview

Features

- UL-Listed Cylindrical Cells
- Safe & Non-Toxic LiFePO₄ Chemistry
- Optional Integrated Heating (Model: BBGC3H)

Performance & Versatility

- Series and/or Parallel Connection
- Wire in Series up to 48V
- No Limit When Wiring in Parallel
- Mount in Any Orientation
- 100% Depth of Discharge
- 3,000-5,000 Deep Discharge Cycles

Certified and Tested To Industry Safety Standards

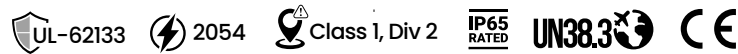

*Class 1, Division 2 Listing is Not Applicable for Heated Version

Internal BMS

Proprietary battery management system (BMS) ensures user safety and product protection.

- High/Low Voltage Protection
- Short Circuit Protection
- High/Low Temperature Protection
- Cold Charging Protection (Low-Temp Cutoff)
- Automatic Cell Balancing at Top of Charge

300 Amps Continuous | 500 Amps Surge for 30 Seconds | 1/2 Second Surge for Loads over 500 Amps

*Note: This built-in protection will reset after five seconds in most fault conditions. Disconnecting the battery from loads will also reset the BMS.

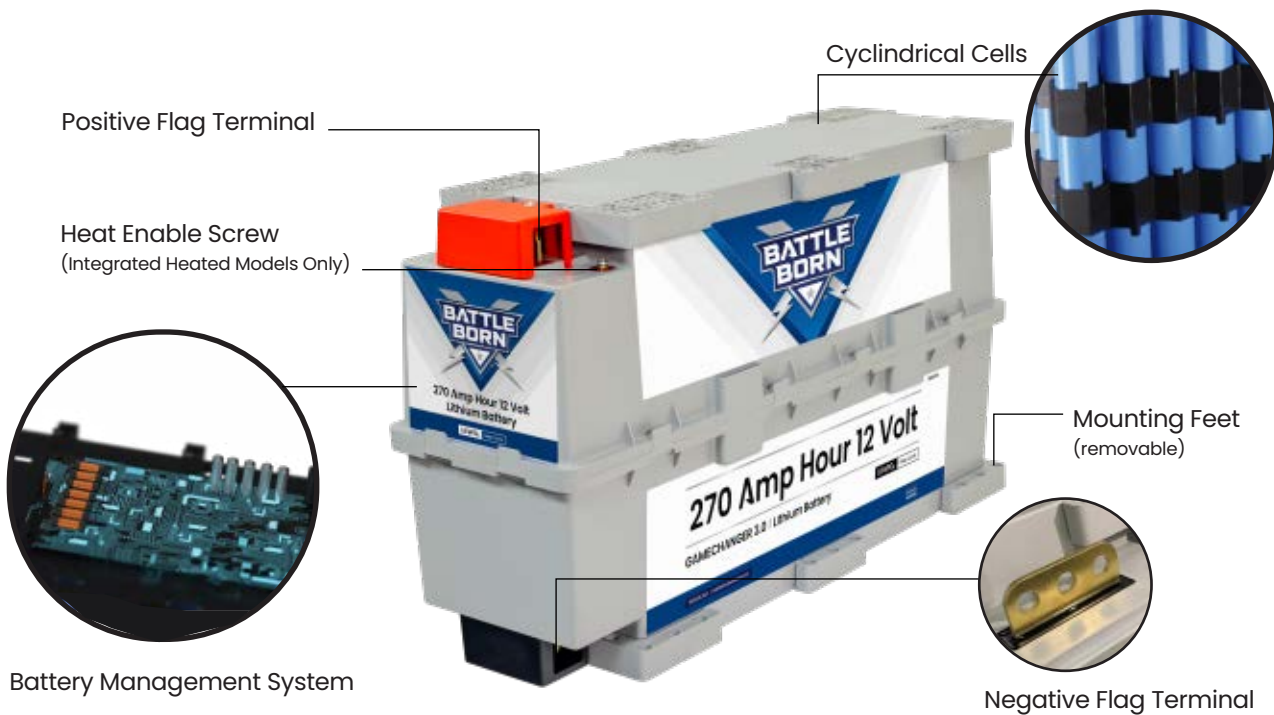

Optional Integrated Heating Technology

All Smart LiFePO₄ Batteries are available in models with optional Integrated Heating technology, which warms the battery pack's internal cells in cold temperatures.

- Allows for Cold Weather Charging
- Low Continuous Power Draw When Enabled
- Integrated Heating Technology Activated at Internal Temperature of ~35°F (*When Heat Function is Enabled)
- Operating Temperature Range of -4°F to 135°F

Note: If you have a heat-enabled model, please refer to the additional Integrated Heating Instruction manual prior to use and installation.

INTEGRATED
HEATING

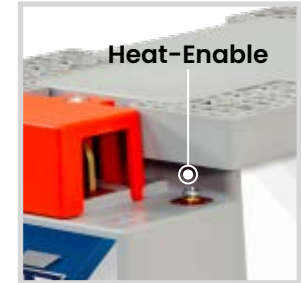

Optional Dragonfly Intelligence® Smart Communication Technology

Dragonfly Intelligence® is the proprietary communication technology inside Battle Born Smart LiFePO₄ Batteries.

- Robust Wireless Mesh Network & Bluetooth® Connectivity
- Quick Setup & Easy Configuration via the Battle Born® Mobile App
- Compatible with RV-C, NMEA 2000 & More (Some Protocols are Coming Soon)
- Remote Monitoring of Individual Batteries or Entire Smart Power System
- Error Detection & Warning Notifications
- Historical Reporting of SOC, Voltage, Performance, System Health & More

DRAGONFLY
Intelligence

BBGC3 Technical Specifications

Electrical Specifications

Voltage	12V
Capacity	270Ah
Operating Temperature	-4°F to 135°F (-20°C to 57.2°C)
Efficiency	99%
Self Discharge	2-3% per Month
Maximum Series Voltage	48V
Cycle	3K-5K
Built-in BMS	Internal
Resistance	5 mΩ
Usable Depth of Discharge	100%

Discharging Specifications

Max Discharge Current	300A
Peak Discharge Current	500A for 30 Seconds
Surge for Loads Over 500A	.5 Seconds
Recommended Low Voltage Disconnect	10.5V
BMS Discharge Voltage Cut-Off	10V
Reconnect Voltage	10V
Short Circuit Protection	Yes

Recognized Specifications

Battery Cell Certifications	UL 1642
Battery Pack Certifications	UN38.3 UL/CSA-62133-2 UL-2054 IP65 - ANSI/IEC 60529-2020, CSA 60529:16 (R2021) Class 1, Division 2, Group A, B, C & D UL 121201:2019, CSA C22.2 No.213-17
Shipping Class	UN3480, Class 9

Temperature Specifications

Discharge Temperature	-4°F to 135°F (-20°C to 57.2°C)
Charge Temperature	25°F to 135°F
Storage Temperature	-10°F to 140°F (-23°C to 60°C)
BMS High Temperature Cut-Off	>135°F
BMS Reconnect Temperature	<135°F

Charging Specifications

Recommended Charge Current	.5C
Max Charge Current	135A
Absorption Voltage	14.2V to 14.6V
Float Voltage	13.4V to 13.8V
Equalization Voltage (if applicable)	14.4V
Absorption Time	100 Minutes per 270Ah Battery Bank
BMS Charge Current Cut-Off	.5C Recommended
Recharge/Rebulk Voltage	13.3V
BMS Cell Balancing Voltage Range	14.2V to 14.6V
High BMS Voltage Protection	14.7VDC
Temperature Compensation	No/Disable

Mechanical Specifications

Dimensions	22.83"L X 7.09"W X 13.15"H
Weight	80.8 lbs.
Terminal Type	.25" Brass
Terminal Hole	3/8" Hole and 3/8" or 5/16" Hardware is Suggested
Terminal Torque	9 to 11 Ft-lb.
Case Material	ABS Fire Rated
Cell Type	Cylindrical
Cell Chemistry	LiFePO4 (Lithium Iron-Phosphate)
Sealed and Water Resistant Case	Non-Submersible

Integrated Heating Specifications (Model BBGC3H Only)

Heat	Integrated Heating Technology
Heat Enable Terminal	Female M4 Thread
Continuous Power Draw (When Enabled)	28W

*Note: The storage temperature range is -10°F to 140°F (-23°C to 60°C). We recommend bringing the batteries to a 100% charge and then disconnecting them completely for storage. After six months in storage, your batteries will remain 75 to 80% charged.

Storing batteries in subzero weather (-15°F or more) has the potential to crack the ABS plastic and more importantly could cause a faster loss of capacity, in some cases drastically more than the typical 2 to 4% per month loss.



What is in the Box?

Included with Your Purchase:

- (1) 270 Amp Hour 12 Volt LiFePO₄ Deep Cycle Battery
Model: BBGC3/BBGC3H
- (1) Finishing Hardware Kit
 - (2) '18-8 Stainless Steel' 5/16-18 x 1" bolts
 - (2) '18-8 Stainless Steel' 5/16-18 x 1 1/4" bolts
 - (4) Washers
 - (2) Nylok nuts

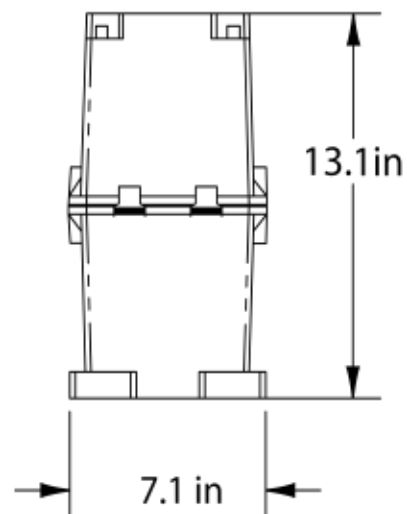
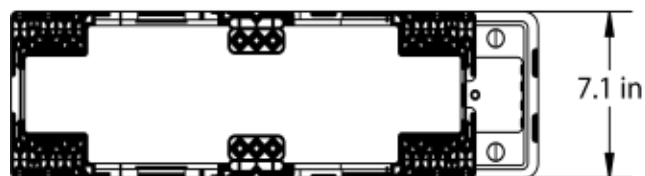
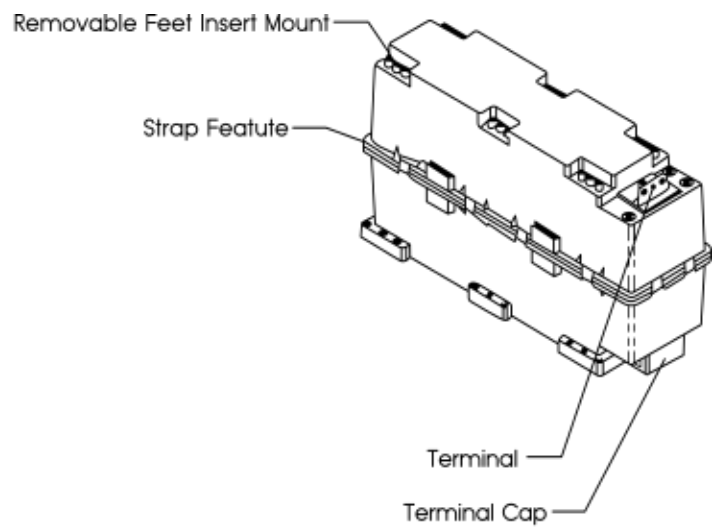
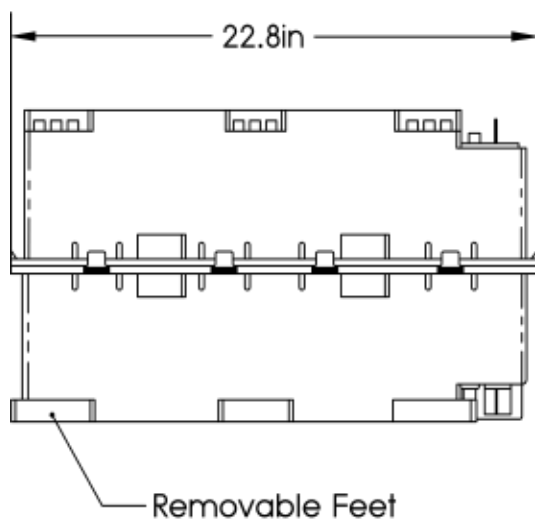



Battery Safety



LiFePO₄ batteries are inherently safe; however, like all batteries, energy storage devices, and electrical equipment, they pose potential safety and electrical hazards. Failure to follow these safety instructions could result in electrical shock, injury, or death, as well as damage to the battery, equipment, or property.

WARNING

Failure to follow these safety guidelines can result in property damage, personal injury, or worse. Please read the following material carefully before installation or use:

- Do **NOT** short battery terminal.
- Do **NOT** reverse polarity.
- Do **NOT** pierce the battery casing.
- Do **NOT** attempt to disassemble.
- Do **NOT** drop or mishandle.
- Do **NOT** immerse in water.
- Do **NOT** operate with loose connections.
- Do **NOT** operate the battery in series or in parallel with any other type of battery.
- Do **NOT** operate using cables that cannot accommodate the maximum current that can be delivered by the batteries

Please contact technical support to verify that you are using appropriate cables and contacts.

If the product is damaged upon arrival, please contact the manufacturer for product support.

Class 1, Division 2, Group A, B, C, D	Classe 1, Division 2, Groupe A, B, C, D
<ul style="list-style-type: none">• Always store in a Type 3R enclosure when used in outdoor environments• WARNING: DO NOT OPEN WHEN A HAZARDOUS AREA MAY BE PRESENT	<ul style="list-style-type: none">• Toujours stocker la batterie dans un boîtier de type 3R lorsqu'elle est utilisée en extérieur.• AVERTISSEMENT : NE PAS OUVRIR EN PRÉSENCE D'UNE ZONE DANGEREUSE.

DISCLAIMERS

- The buyer assumes responsibility for any damages resulting from the misuse of our products.
- Mishandling or misuse of our products will void the warranty.

INSTALLATION

- The battery should be installed as per national and local codes
- The battery should only be installed in locations approved by local building codes.
- Always store in a Type 3R enclosure when used in outdoor environments.
- Electrical and shock hazards can be minimized by covering the solar array and using insulated tools.
- Do not short the battery terminals.
- Do not install the battery if there are any signs of physical damage.
- Do not install the battery in a location that may be flooded.

OPERATION

- Use only approved battery chargers for charging the battery.
- Do not disassemble the battery.

EMERGENCY

- Disconnect the battery from the system.
- Wear a respirator, eye protection, and rubber gloves where appropriate.
- Use an ABC type dry chemical fire extinguisher.
- Dispose of as per local regulations.

DISPOSAL

- This product contains lithium-ion batteries and other recyclable materials.
- We strongly encourage customers to recycle unused or retired batteries.
- For guidance on proper recycling methods, please contact us directly.
- Ensure that unused or retired batteries are disposed of responsibly and in compliance with local laws and regulations.



Installation Guide

What Do I Need for Installation?

If your system is already set up and ready for the batteries, you will need a torque wrench capable of properly torquing the 5/16" finishing hardware.

- **Important:** Properly torque the hardware to 9 to 11 ft-lbs. Failure to meet this specification may result in system damage or failure.

Connecting Load Specified Cables to the Batteries

1. Identify Terminals:

- Positive (+): Red
- Negative (-): Black

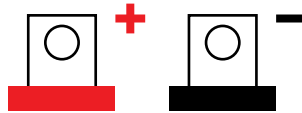

Select Hardware:

- Choose the appropriate finishing hardware set.
- Ensure the bolt can fully seat into the nylok insert of the nut.
- If multiple lugs are used, longer bolts may be required for the bolt to fully seat into the nylok insert of the nut

3. Connect Cables:

- Attach the positive load specified cable lug to the positive terminal.
- Attach the negative load specified cable lug to the negative terminal.
- Follow the order shown in the diagram below for correct connection.

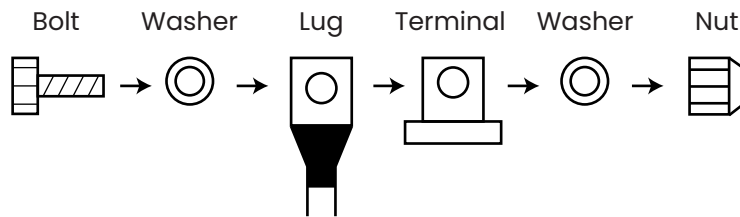

4. Secure Connections:

- Do NOT finger tighten.
- Use a torque wrench to tighten hardware to the specification of 9-11 ft-lbs.
- Inadequate tightening can result in severe damage and void the warranty.
- Reference the diagram below for a demonstration of proper and improper connections

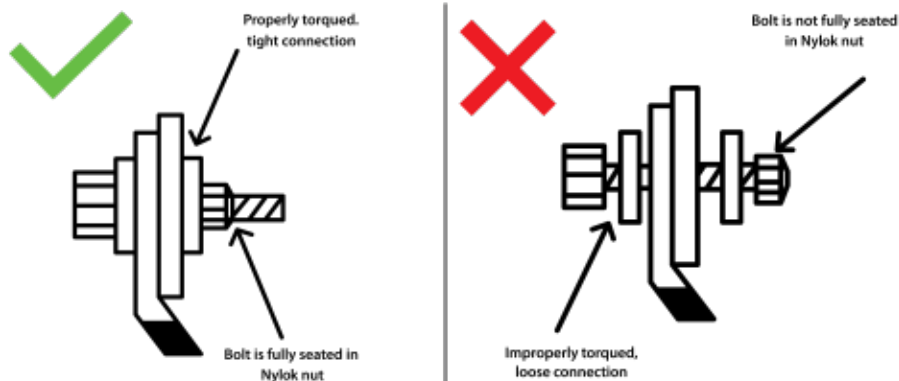



Properly Charging the Batteries

How to Properly Charge Your Battle Born Batteries

To ensure optimal performance and longevity, it's crucial to charge your Battle Born batteries correctly. Please verify that any charging component in your system (such as converters, inverter chargers, solar charge controllers, or DC-to-DC chargers) are capable of being programmed to the following specifications:

Charging Profile

Bulk/Absorption	14.2V - 14.6V
Absorption Time	60-90 minutes per battery (for parallel string)
Float	13.4V - 13.8V
Equalization	14.4V/ Disabled
Temperature Compensation	0/Disabled
Charge Rate	.5c

Operating Temperature Range

Battery Charge Temperature Range	32°F to 131°F (0°C to 55°C)
Battery Discharge Temperature Range	-4°F to 140°F (-20°C to 60°C)
Cell Charge Temperature	32°F to 131°F (0°C to 55°C)
Cell Discharge Temperature	-4°F to 140°F (-20°C to 60°C)

Note: Not all chargers support multi-stage charging. If your charger is not capable, ensure it can be programmed for the Bulk/Absorption voltage and that other features like equalization and temperature compensation are disabled. Please consult your charger's manual or the manufacturer for specific instructions.



Parallel Batteries Connection

Why Connect in Parallel?

Multiple BBGC3 batteries may be connected in parallel to increase the capacity and current of the system. When batteries are connected in parallel, the voltage of the system does not change, but the capacity and current limits are additive. For example, two BBGC3 batteries connected in parallel (shown in the diagrams below) create a 12V 200Ah bank that can deliver 200A continuously and 200A for 30 seconds.

How to Make a Parallel Connection

Note: All cables and connections MUST be able to accommodate the high currents that can be delivered by the battery. Appropriate fuses and circuit breakers are highly recommended to protect downstream components from current spikes and short circuits.

1. Identify the positive and negative terminals. These are labeled and color-coded **red for positive (+)**, **black for negative (-)**.
2. Determine the appropriate finishing hardware set you will use. Verify that your bolt can fully seat into the nylok insert of the nut. If multiple lugs are used, longer bolts may be required for the bolt to fully seat into the nylok insert of the nut.
3. Make the proper cable connections to the positive of the first battery. Please reference the diagram on page 14 below "Connect Cables" for the proper order of hardware.
4. When connecting to your battery terminals, **DO NOT** finger tighten. Use a torque wrench to torque your hardware to the specification of 9 to 11 ft-lbs. Failure to adequately secure connections can result in severe damage and will void your warranty.
5. Connect the other end of your positive cable to the positive terminal of the other battery you are connecting to. Repeat step 4.
6. Repeat steps 3-5 for the negative connections.
7. Repeat steps 3-6 for additional batteries in the system. An example of a finished connection can be found in the diagrams below.

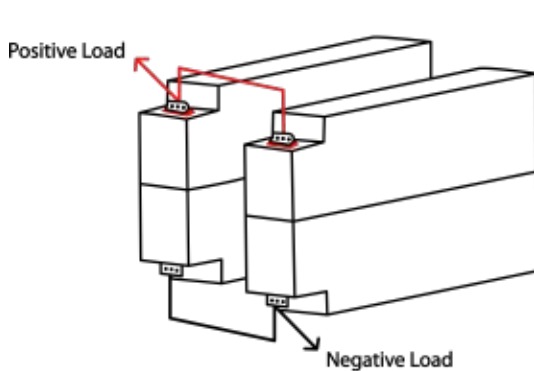

Two GC3 Batteries connected in Parallel to create a 12V 540Ah Battery Bank

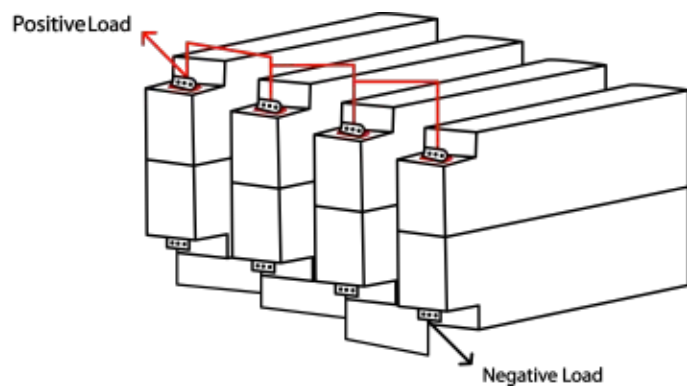

Four GC3 Batteries connected in Parallel to create a 12V 1,080Ah Battery Bank



Series Batteries Connection

Why Connect in Series?

When batteries are connected in series, current capacities remain the same, but the system voltage is additive. For example, two BBGC3 batteries connected in series form a 24V 100Ah bank (shown in the diagrams below) and should be charged using a bulk and absorption voltage of 28.8V, and a float voltage of 27.2V.

How to Make a Series Connection

Note: Battle Born GC3 batteries are capable of being connected in series up to 48V. DO NOT exceed a 48V setup or you will void the batteries' warranty.

1. Before making any connections, make sure to charge each battery up to 14.2V - 14.6V with a proper lithium charger. **ALL BATTERIES SHOULD BE AT THE SAME STATE OF CHARGE PRIOR TO CONNECTING**, otherwise you will encounter balance issues within your system. You can check your battery's state of charge with a multimeter.
2. Identify the positive and negative terminals. These are labeled and color-coded **red for positive (+)**, **black for negative (-)**.
3. Determine the appropriate finishing hardware set you will use. Verify that your bolt can fully seat into the nylok insert of the nut. If multiple lugs are used, longer bolts may be required for the bolt to fully seat into the nylok insert of the nut.
4. Make the proper cable connections to the negative of the first battery. Please reference the diagram on page 14 below "Connect Cables" for the proper order of hardware.
5. When connecting to your battery terminals, **DO NOT** finger tighten. Use a torque wrench to torque your hardware to the specification of 9 to 11 ft-lbs. Failure to adequately secure connections can result in severe damage and will void your warranty.
6. Connect the other end of your cable to the positive terminal of the other battery you are connecting to. Repeat step 4.
7. Repeat steps 3-6 for additional batteries, but **DO NOT** exceed 48V. An example of a correct series connection can be found in the diagrams below.

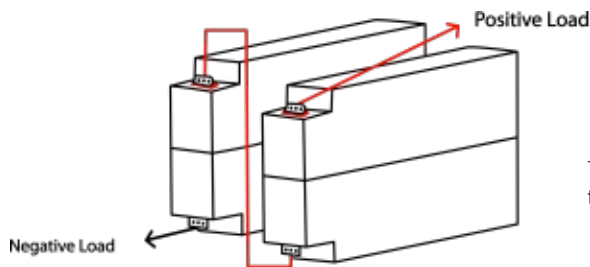

Two GC3 Batteries connected in series to create a 24V 270Ah Battery Bank

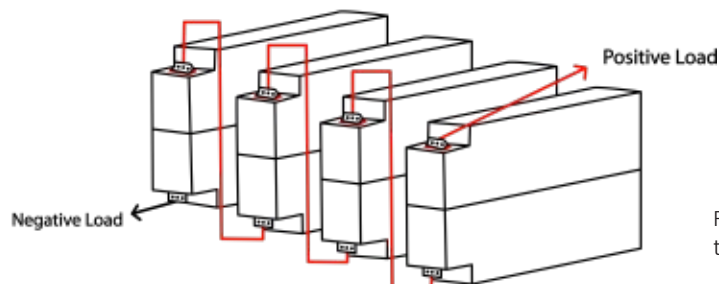

Four GC3 Batteries connected in series to create a 48V 270Ah Battery Bank



Battery Management System (BMS)

All Battle Born Batteries come equipped with a built-in Battery Management System (BMS) designed to safeguard the cells from various extreme conditions, thereby extending their lifespan and shielding your electrical system from potential damage.

BBGC3 | BBGC3H BMS

- Max Continuous Current: 300 Amps
- Max Surge Current: 500 Amp surge for 30 seconds
- 1/2 second surge for loads over 500 Amps

High Voltage Disconnect (> 14.7V)

If an individual cell voltage exceeds a prescribed threshold during charging, the BMS will prevent a charge current from continuing. Discharge is always allowed under this condition. If the batteries have not been balanced for a long time, high voltage disconnect could occur at a lower voltage. The batteries will rebalance after several full charges.

Low-Voltage Disconnect (< 10.6V)

If an individual cell falls below a prescribed threshold during discharge, the BMS will prevent further discharge. Although the battery is in "low-voltage disconnect" mode, it will still allow a charging current.

Note: Many chargers must detect a voltage over 10V to send a charge to the battery. Please be aware that some chargers may not sense a battery in low-voltage disconnect and you may need to jump it with a 12V source to "wake up" the battery. You should jump your battery within 24hrs of entering low-voltage disconnect otherwise you risk damaging your battery and voiding the warranty.

High Temperature Charging and Discharging

The BMS will not allow a charging current if the battery's internal temperature exceeds 131°F (55°C).

The BMS will prevent discharging if the battery's internal temperature reaches 140°F (60°C) or higher.

Low Temperature Charging (< 25°F/-3.9°C)

The BMS will not allow a charging current under 32°F (0°C) but will continue to discharge down to -4°F (-20°C).

Note: The BBGC3 | BBGC3H has an operating temperature range of -4°F (-20°C) to 131°F (55°C).

High Current Discharge Surges

The BMS will not allow a current that exceeds 500 (+/- 5%) Amps for more than 30s, or anything larger for 0.5s. After a high current disconnection, the battery will automatically reconnect after 5 seconds.

Short Current Discharge Surges

The Battery Management System (BMS) incorporates built-in short circuit protection. In the event of a short circuit, the BMS will automatically shut down the battery and remain in a disconnected state until the battery cables are removed.

To resolve this issue and re-establish battery functionality:

- Disconnect the battery cables.
- Use a voltmeter to measure the battery voltage.
- If the voltage reading exceeds 10V, reconnect the battery cables.
- If the voltage reading is below 10V, please contact our technical support team for further assistance.

Balancing of Cells

A passive balancing process is activated by the BMS at the top of each charge cycle when the battery voltage exceeds around 14.2V. This ensures that all the cells remain at the same state of charge, which helps pack longevity and performance.



Additional System Considerations

Cable Sizing for System Installation

Proper cable sizing is crucial for optimal system performance and safety. Several factors influence cable selection. Use this chart (the diagram shown below) as a general reference for selecting appropriate cable gauges based on the current and distance in your system.

1. Load Size: Determine the power consumption of the devices you intend to power with the battery bank.
2. Cable Length: Consider the distance between the battery and the load.
3. Voltage Drop: Calculate voltage drop to ensure adequate power delivery.

Important Considerations:

- Amperage Capacity: Cables have limitations on the amount of current they can safely carry.
- Cable Specifications: Verify the specific amperage rating of your chosen cable.
- Power Draw: Ensure that the cable's capacity aligns with the combined power draw of your connected devices.

By carefully considering these factors, you can select appropriate cables to prevent potential failures and damage to your system.

CURRENT (A)	0-5	16 AWG	16 AWG	16 AWG	16 AWG	14 AWG	12 AWG	12 AWG
	5-10	16 AWG	16 AWG	14 AWG	12 AWG	10 AWG	10 AWG	10 AWG
	10-15	14 AWG	14 AWG	12 AWG	10 AWG	10 AWG	8 AWG	8 AWG
	15-20	14 AWG	12 AWG	12 AWG	10 AWG	8 AWG	6 AWG	6 AWG
	20-25	12 AWG	10 AWG	10 AWG	8 AWG	6 AWG	6 AWG	6 AWG
	25-30	10 AWG	10 AWG	10 AWG	8 AWG	6 AWG	6 AWG	4 AWG
	30-40	8 AWG	8 AWG	8 AWG	6 AWG	6 AWG	4 AWG	4 AWG
	40-50	8 AWG	8 AWG	6 AWG	6 AWG	4 AWG	4 AWG	2 AWG
	50-60	6 AWG	6 AWG	6 AWG	4 AWG	4 AWG	2 AWG	2 AWG
	60-70	6 AWG	6 AWG	4 AWG	4 AWG	2 AWG	2 AWG	1/0 AWG
	70-80	4 AWG	4 AWG	4 AWG	4 AWG	2 AWG	2 AWG	1/0 AWG
	80-90	4 AWG	4 AWG	4 AWG	2 AWG	2 AWG	1/0 AWG	1/0 AWG
	90-100	2 AWG	2 AWG	2 AWG	2 AWG	2 AWG	1/0 AWG	1/0 AWG
	100-120	2 AWG	2 AWG	2 AWG	2 AWG	1/0 AWG	1/0 AWG	2/0 AWG
	120-150	1/0 AWG	1/0 AWG	1/0 AWG	1/0 AWG	1/0 AWG	2/0 AWG	4/0 AWG
	150-200	2/0 AWG	2/0 AWG	2/0 AWG	2/0 AWG	2/0 AWG	4/0 AWG	4/0 AWG
	0-4	4-7	7-10	10-15	15-20	20-25	25-30	
LENGTH IN FEET								

Recommended Cable Gauge Based on Current and Distance.

How to Incorporate Fuses into System Install

ANL fuses are designed to protect your system by melting and separating in case of excessive current. These fuses are essential components for protecting against a catastrophic event and should be placed between your Battle Born Battle Born Batteries and the inverter/load.

Voltage vs. Capacity (Single Battery)

Battle Born LiFePO4 batteries, exhibit a characteristic voltage drop during discharge.

The provided voltage vs. capacity charts illustrate the relationship between battery voltage and remaining capacity at different discharge rates. The curves on the chart represent the voltage profile for various discharge currents. It's evident that higher discharge rates result in a steeper voltage decline.

14.4V	100%
13.6V	100%
13.4V	99%
13.3V	90%
13.2V	70%
13.1V	40%
13.0V	30%
12.9V	20%
12.8V	17%
12.5V	14%
12.0V	9%
10.0V	0%

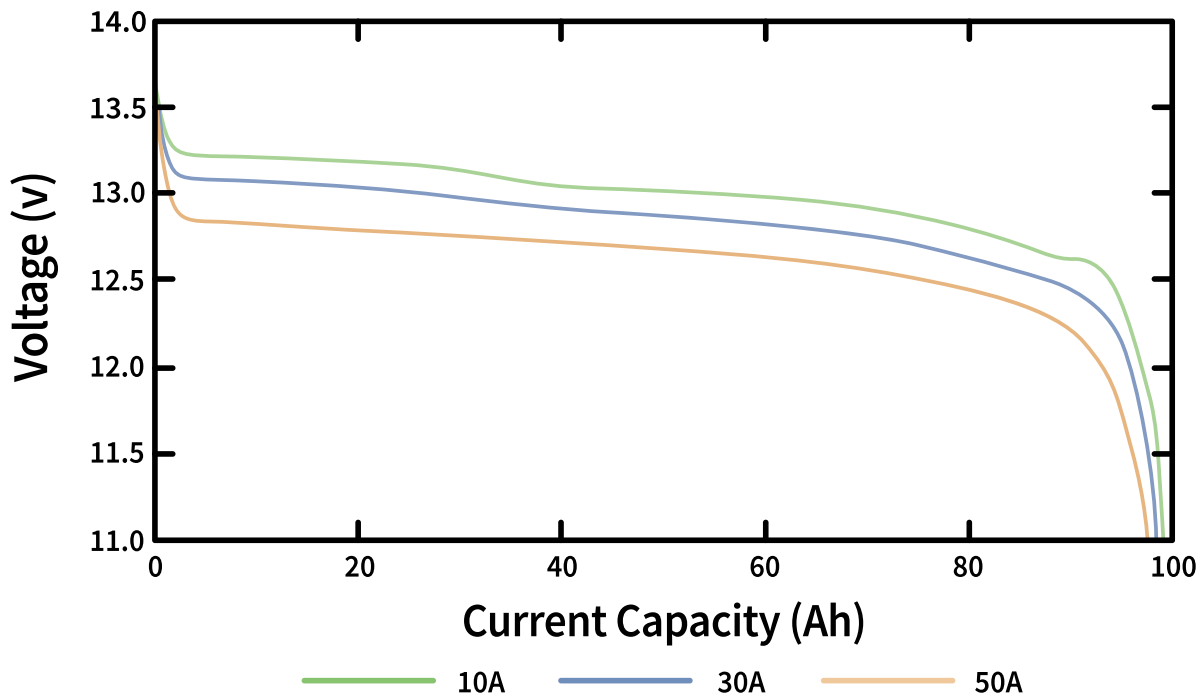



**Storage, Maintenance,
Recycling & Disposal**

Battery Storage Recommendations

- **Charge Fully:** Bring batteries to 100% state of charge.
- **Disconnect Load:** Remove the negative cable from one battery.
- **Monitor Capacity:** Batteries lose 2-3% capacity per month
 - **Subject to increasing if stored in extreme environmental conditions*

Battery Maintenance

Battle Born Batteries require minimal maintenance, but the following recommendations will help ensure your system remains in optimal condition:

- **For Batteries in Series:** If your batteries are not charged by a multi-bank charger, it is recommended to fully charge each battery individually once per year, especially with frequent use. This process internally balances the batteries, helping them achieve their expected lifespan and deliver full power with each use.
- **For Batteries in Parallel:** Individual charging is unnecessary. Simply ensure the batteries are charged to 14.2V – 14.6V regularly to maintain internal balance. The built-in Battery Management System (BMS) includes a passive balancing feature that will automatically handle this process for you.

Note: A Current Surge Limiter (CSL) is required for use with inverters rated at 3500W or higher.

How to Properly Recycle and Dispose of Batteries

Dragonfly Energy, maker of Battle Born Batteries, is committed to providing long-lasting green energy solutions that support your adventures for years. In addition to building durable, reliable batteries, we offer industry-leading customer support to help you maximize their lifespan. When your batteries do reach the end of their life, it's important to recycle them responsibly.

Please check with local services for guidance on safe disposal options.

Recycling your batteries properly helps protect the environment and supports our shared mission of sustainability.



Warranty, Returns & Shipping

Limited Warranty

Please find Limited Warranty information online at www.battlebornbatteries.com/limited-warranty/ or via phone at (855) 292-2831.

Return Policy

You have 30 calendar days to return an item from the invoice date. To be eligible for a return, your item must be in the same condition that you received it in. You must have the receipt or proof of purchase. If an item is new, unused, and in the original packaging, we are happy to accept a return up to 30 days from the original invoice date with no restocking fee. The item must be returned with its original packaging. Original packaging must be in the same condition as it was received, otherwise you may be responsible for a restocking fee. If the item has been installed, used, or no longer has the original packaging, we will assess a restocking fee that will be shared when the return merchandise authorization (RMA) is issued. Items 60 days past the original invoice will be reviewed at Battle Born's discretion.

Returns will not be accepted without an RMA number, which can be obtained by filling out the return form at <https://battlebornbatteries.com/returns/>.

To avoid being charged restocking fees, review the full return/refund policy at www.battlebornbatteries.com/terms-conditions/#returns.

Refund Policy

You have 30 calendar days to return an item from the invoice date. Once we receive your item, we will inspect it and notify you that we have received your returned item. We will immediately notify you of the status of your refund after inspecting the item. If your return is approved, we will initiate a refund to your credit card (or original method of payment). You will receive the credit within a certain amount of days, depending on your card issuer's policies. No refund is guaranteed after the initial 30 days has passed or if the item has been used.

Shipping

You will be responsible for paying for your own shipping costs for returning your item. If you are returning prior to 30 days from the original ship date, you may be eligible for a free return. In order to be eligible for free shipping, you MUST have the original packing in which the order was shipped, including boxes, foam, wrapping, and pallets if necessary. Not all items will be eligible for free return shipping. Shipping costs are nonrefundable. If you receive a refund, the cost of return shipping may be deducted from your refund.

If you have any questions, please contact us by calling 855-292-2831 or email us at info@battlebornbatteries.com.

BATTLE BORN®

Unstoppable Power Solutions

Notice: Product improvements and enhancements are continuous; therefore, the specifications and information contained in this document may change without notice. Dragonfly Energy Corp. shall not be liable for errors contained herein or for incidental or consequential damages in connection with the furnishing, performance, or use of this material. No part of this document may be photocopied, reproduced, or translated to another language without the prior written consent of Dragonfly Energy Corp.

Copyright © 2024, Dragonfly Energy Corp., all rights reserved. Battle Born Batteries® and Battle Born® are registered trademarks of Dragonfly Energy Corp. All other trademarks, trade names, service marks, and logos referenced herein belong to their respective owners.