

## MultiPlus 2kVA 120V

# Table of Contents

<b>1. IMPORTANT SAFETY INSTRUCTIONS - SAVE THESE INSTRUCTIONS</b> .....	<b>1</b>
<b>2. Description</b> .....	<b>3</b>
2.1. General .....	3
2.2. Battery charger .....	3
2.3. Self consumption – solar energy storage systems .....	4
<b>3. Operation</b> .....	<b>5</b>
3.1. On / Off / Charger-only Switch .....	5
3.2. Remote control .....	5
3.3. LED Indications .....	5
<b>4. Installation</b> .....	<b>7</b>
4.1. Location .....	7
4.2. Connection of the Battery cables .....	7
4.3. Connection of the AC cabling .....	8
4.4. Optional Connections .....	8
4.4.1. Second Battery .....	8
4.4.2. Temperature Sensor .....	8
4.4.3. Remote Control .....	8
4.4.4. Programmable relay .....	8
4.4.5. Parallel Connection (see appendix C) .....	8
4.4.6. Three-phase operation (see appendix D) .....	9
<b>5. Configuration</b> .....	<b>10</b>
5.1. Standard settings: ready for use .....	10
5.2. Explanation of settings .....	10
5.3. Configuration of the MultiPlus .....	12
5.3.1. VE.Bus Quick Configure Setup .....	12
5.3.2. VE.Bus System Configurator .....	12
5.4. Configuration with DIP switches .....	12
5.4.1. DIP switch 1 to 3 .....	13
5.4.2. Exemplary settings .....	13
<b>6. Maintenance</b> .....	<b>15</b>
<b>7. Trouble Shooting Table</b> .....	<b>16</b>
<b>8. APPENDIX</b> .....	<b>18</b>
8.1. Appendix A: overview connections .....	18
8.2. Appendix B: installation information .....	18
8.3. Appendix C: parallel connection .....	19
8.4. Appendix D: three-phase connection .....	19
8.5. Appendix E: charge algorithm .....	20
8.6. Appendix F: temperature compensation .....	21
8.7. Appendix G: dimensions .....	22

# 1. IMPORTANT SAFETY INSTRUCTIONS - SAVE THESE INSTRUCTIONS

## General

This manual contains important safety and operating instructions for marine unit MultiPlus.

**CAUTION** – To reduce risk of injury, charge only VRLA or Li-Ion rechargeable batteries. Other types of batteries may burst causing personal injury and damage.

Do not expose charger to rain or snow.

Use of an attachment not recommended or sold by the marine unit manufacturer may result in a risk of fire, electric shock, or injury to persons.

Do not disassemble marine unit; take it to a qualified serviceman when service or repair is required. Incorrect reassembly may result in a risk of electric shock or fire.

To reduce risk of electric shock, unplug marine unit from outlet before attempting any maintenance or cleaning. Turning off controls will not reduce this risk.



**WARNING: RISK OF EXPLOSIVE GASES**

WORKING IN THE VICINITY OF A LEAD-ACID BATTERY IS DANGEROUS. BATTERIES GENERATE EXPLOSIVE GASES DURING NORMAL BATTERY OPERATION. FOR THIS REASON, IT IS OF THE UTMOST IMPORTANCE THAT EACH TIME BEFORE SERVICING THE UNIT IN THE VICINITY OF THE BATTERY, YOU READ THIS MANUAL AND FOLLOW THE INSTRUCTIONS EXACTLY.

To reduce risk of battery explosion, follow these instructions and those published by battery manufacturer and manufacturer of any unit you intend to use in the vicinity of the battery. Review cautionary marking on these products and on engine.

## PERSONAL PRECAUTIONS

- i. Someone should be within range of your voice or close enough to come to your aid when you work near a lead-acid battery.
- ii. Have plenty of fresh water and soap nearby in case battery acid contacts skin, clothing, or eyes.
- iii. Wear complete eye protection and clothing protection. Avoid touching eyes while working near battery.
- iv. If battery acid contacts skin or clothing, wash immediately with soap and water. If acid enters eye, immediately flood eye with running cold water for at least 10 min and get medical attention immediately.
- v. NEVER smoke or allow a spark or flame in the vicinity of the battery or engine.
- vi. Be extra cautious to reduce risk of dropping a metal tool onto battery. It might spark or short-circuit battery or other electrical part that may cause explosion.
- vii. Remove personal metal items such as rings, bracelets, necklaces, and watches when working with a lead-acid battery. A lead-acid battery can produce a short-circuit current high enough to weld a ring or the like to metal, causing a severe burn.
- viii. NEVER charge a frozen battery.
- ix. If necessary to remove battery from vessel, always remove grounded terminal from battery first. Make sure all accessories in the vessels are off, so as not to cause an arc.
- x. Be sure area around battery is well ventilated.
- xi. Clean battery terminals. Be careful to keep corrosion from coming in contact with eyes.
- xii. Study all battery manufacturer's specific precautions such as removing or not removing cell caps while charging and recommended rates of charge.
- xiii. Add distilled water in each cell until battery acid reaches level specified by battery manufacturer. This helps purge excessive gas from cells. Do not overfill. For a battery without cell caps, carefully follow manufacturer's recharging instructions.

## MARINE UNIT LOCATION

- i. Locate marine unit away from battery in a separate, well ventilated compartment.
- ii. Never place marine unit directly above battery; gases from battery will corrode and damage marine unit.
- iii. Never allow battery acid to drip on marine unit when reading gravity or filling battery.

- iv. Do not operate marine unit in a closed-in area or restrict ventilation in any way.

### DC CONNECTION PRECAUTIONS

Connect and disconnect DC output connections only after setting any marine unit switches to off position and removing AC cord from electric outlet or opening AC disconnect.

EXTERNAL CONNECTIONS TO CHARGER SHALL COMPLY WITH THE UNITED STATES COAST GUARD ELECTRICAL REGULATIONS (33CFR183, SUB PART I).

### GROUNDING INSTRUCTIONS

This marine unit should be connected to a grounded, metal, permanent wiring system; or an equipment-grounding conductor should be run with circuit conductors and connected to equipment-grounding terminal or lead on unit. Connections to unit should comply with all local codes and ordinances.

Please familiarize yourself with the safety features and instructions by first reading the documentation supplied with this product before using the equipment. This product has been designed and tested in accordance with international standards. The equipment must be used exclusively for the purpose for which it was designed.



#### ELECTRIC SHOCK HAZARD

The product is used in conjunction with a permanent energy source (battery). Input and/or output terminals may still be dangerously energized, even when the equipment is switched off. Always switch off the AC supply and the battery before carrying out maintenance or servicing the product.

The product has no internal user-serviceable components. Do not remove the front plate or operate the product if any panels have been removed. All servicing must be undertaken by qualified personnel.

Never use the product where there is a risk of gas or dust explosions. Consult the battery manufacturer's information to ascertain that the product is intended for use in conjunction with the battery. Always comply with the battery manufacturer's safety instructions.

Never try to charge non-rechargeable - or frozen batteries.

The converter/inverter is intended to recharge batteries. The battery that is connected to this product is only suitable if it complies with the given battery standard for that battery type and is provided with a battery management system that will monitor and control the electrical and thermal health of the battery during charging. When installing this converter/inverter, the battery is to be verified as in compliance with the applicable battery standard.

This appliance is not intended for use by persons (including children) with reduced physical, sensory or mental capabilities, or lack of experience and knowledge, unless they have been given supervision or instruction concerning use of the appliance by a person responsible for their safety. Children should be supervised to ensure that they do not play with the appliance.



Do not lift heavy loads without assistance.

### Installation

Read the installation instructions in the installation manual before installing the equipment.

This is a Safety Class I product (supplied with a protective grounding terminal). **Uninterruptible protective grounding must be provided at the AC input and/or output terminals. Alternatively, the grounding point located externally on the product may be used.** Whenever it is likely that the grounding protection has been damaged, the product must be turned off and secured against unintended operation; please contact qualified service staff.

Ensure that the DC and AC input cables are fused or fitted with circuit breakers.

Ensure that the equipment is used under the correct ambient conditions. Never operate the product in a wet or dusty environment. Ensure there is adequate free space for ventilation around the product and check that the ventilation vents are not blocked.

Ensure that the required system voltage does not exceed the product's capacity.

### Transport and Storage

Ensure that the mains power and battery leads have been disconnected before storing or transporting the product.

No liability can be accepted for any transport damage if the equipment is shipped in non-original packaging.

Store the product in a dry environment; the storage temperature must be between -40°C and 70°C.

Consult the battery manufacturer's manual in respect of transport, storage, charging, recharging and disposal of the battery.

## 2. Description

### 2.1. General

#### Multifunctional

The MultiPlus gets its name from the multiple functions it can perform. It is a powerful true sine wave inverter, a sophisticated battery charger that features adaptive charge technology and a high-speed AC transfer switch in a single enclosure. Beside these primary functions, however, the MultiPlus has several advanced features that provide a range of new applications as outlined below.

#### Uninterrupted AC power

In the event of a grid failure, or shore or generator power being disconnected, the inverter within the MultiPlus is automatically activated and takes over supply to the connected loads. This happens so fast (less than 20 milliseconds) that computers and other electronic equipment will continue to operate without disruption.

#### Parallel and 3-phase operation capability

Up to 6 inverters can operate in parallel to achieve higher power output.

Operation in 3-phase configuration is also possible.

#### PowerControl – Dealing with limited generator or shore side power

With a Multi Control Panel a maximum generator or shore current can be set. The MultiPlus will then take account of other AC loads and use whatever is extra for charging, thus preventing the generator or shore supply from being overloaded.

#### PowerAssist – Boosting the capacity of shore or generator power

This feature takes the principle of PowerControl to a further dimension allowing the MultiPlus Compact to supplement the capacity of the alternative source. Where peak power is so often required only for a limited period, it is possible to reduce the size of generator needed or conversely enable more to be achieved from the typically limited shore connection. When the load reduces, the spare power is used to recharge the battery.

#### Programmable relay

The MultiPlus is equipped with a programmable relay that by default is set as an alarm relay. The relay can be programmed for all kinds of other applications however, for example as a starter relay for a generator.

### 2.2. Battery charger

#### Adaptive 4-stage charging characteristics: bulk – absorption – float – storage

The microprocessor-driven adaptive battery management system can be adjusted for various types of batteries. The adaptive function automatically adapts the charging process to battery use.

#### The right amount of charge: variable absorption time

In the event of slight battery discharge, absorption is kept short to prevent overcharging and excessive gas formation. After deep discharging, the absorption time is automatically extended in order to fully charge the battery.

#### Preventing damage due to excessive gassing: the Battery Safe mode

If, in order to quickly charge a battery, a high charge current in combination with a high absorption voltage has been chosen, damage due to excessive gassing will be prevented by automatically limiting the rate of voltage increase once the gassing voltage has been reached.

#### Less maintenance and aging when the battery is not in use: the Storage mode

The Storage mode kicks in whenever the battery has not been subjected to discharge during 24 hours. In the Storage mode float voltage is reduced to 2,2V/cell (13,2V for 12V battery) to minimise gassing and corrosion of the positive plates. Once a week the voltage is raised back to the absorption level to 'equalize' the battery. This feature prevents stratification of the electrolyte and sulphation, a major cause of early battery failure.

#### Two DC outputs for charging two batteries

The main DC terminal can supply the full output current. The second output, intended for charging a starter battery, is limited to 1A and has a slightly lower output voltage.

#### Increasing service life of the battery: temperature compensation

The temperature sensor (supplied with the product) serves to reduce charging voltage when battery temperature rises. This is particularly important for maintenance-free batteries, which could otherwise dry out by overcharging.

### **More on batteries and charging**

Our book 'Energy Unlimited' offers further information on batteries and battery charging, and is available free of charge on our website (see [www.victronenergy.com](http://www.victronenergy.com) → Support & Downloads' → General Technical Information). For more information on adaptive charging, please also refer to the General Technical Information on our website.

## **2.3. Self consumption – solar energy storage systems**

When the MultiPlus is used in a configuration in which it will feed back energy to the grid it is required to enable grid code compliance by selecting the grid code country setting with the VEConfigure tool.

Once set, a password will be required to disable grid code compliance or change grid code related parameters.

If the local grid code is not supported by the MultiPlus an external certified interface device should be used to connect the MultiPlus to the grid.

Special note for Australian customers: IEC62109.1 certification and CEC approval for off-grid use does NOT imply approval for grid-interactive installations. Additional certification to IEC 62109.2 and AS 4777.2.2015 are required before grid-interactive systems can be implemented. Please check Clean Energy Council website for current approvals.

## 3. Operation

### 3.1. On / Off / Charger-only Switch

When switched to 'on', the product is fully functional. The inverter will come into operation and the LED 'inverter on' will light up.

An AC voltage connected to the 'AC in' terminal will be switched through to the 'AC out' terminal, if within specifications. The inverter will switch off, the 'Charger' LED will light up and the charger commences charging. If the voltage at the 'AC-in' terminal is not within specifications, the inverter will switch on.

When the switch is switched to 'charger only', only the battery charger of the MultiPlus will operate (if mains voltage is present). In this mode input also is switched through to the 'AC out' terminal.





When only the charger function is required, ensure that the switch is switched to 'charger only'. This prevents the inverter from being switched on if the mains voltage is lost, thus preventing the batteries from running flat.





### 3.2. Remote control



Remote control is possible with a switch or with a Multi Control panel. The Multi Control panel has a simple rotary knob with which the maximum current of the AC input can be set: see PowerControl in Section 2.

### 3.3. LED Indications



-  LED off
-  LED flashes
-  LED illuminated

#### Inverter/Charger

	<p><b>On / Off / Charger-only switch = On</b> The inverter is switched on and supplies power to the load.</p>
	<p><b>On / Off / Charger-only switch = On</b> The inverter is switched on and supplies power to the load. Pre-alarm: overload, or battery voltage low, or inverter temperature high</p>
	<p><b>On / Off / Charger-only switch = On</b> The inverter is switched off due to one of the following alarms: overload, or battery voltage low, or inverter temperature high, or DC ripple voltage too high.</p>
	<p><b>On / Off / Charger-only switch = On</b> The AC input voltage is switched through and the charger operates in float mode.</p>

	<p><b>On / Off / Charger-only switch = On. PowerControl and PowerAssist:</b></p> <p>The AC input is switched through and the charge current is zero.</p> <p>The inverter is switched on and, in case of PowerAssist, assists the AC input by supplying additional power to the load (see section 2.1).</p>
	<p><b>On / Off / Charger-only switch = On. Energy Storage System (ESS):</b></p> <p>The AC input voltage is switched through. The inverter is switched on and supplies power to the load, or excess power to the mains.</p>

### Charger only

	<p><b>On / Off / Charger-only switch = Charger only</b></p> <p>The AC input voltage is switched through and the charger operates in bulk or absorption mode.</p>
	<p><b>On / Off / Charger-only switch = Charger only</b></p> <p>The AC input is switched through and the charger operates in float or storage mode.</p>



The MultiPlus will shut down if four abnormal events occur within 30 seconds. The MultiPlus can be reset by switching to Off and then to On.

## 4. Installation



This product should be installed by a qualified electrician.

**CAUTION** – To reduce risk of injury, charge only VRLA or Li-Ion batteries. Other types of batteries may burst causing personal injury and damage!

### 4.1. Location

The product must be installed in a dry and well-ventilated area, as close as possible to the batteries. There should be a clear space of at least 10cm around the appliance for cooling.



1. Excessively high ambient temperature will result in the following:
  - Reduced service life
  - Reduced charging current.
  - Reduced peak capacity, or shutdown of the inverter.
2. Never mount the product directly above the batteries.

For mounting see G



For safety purposes, this product should be installed in a heat-resistant environment. Prevent the presence of e.g. chemicals, synthetic components, curtains or other textiles, etc., in the immediate vicinity.

### 4.2. Connection of the Battery cables

#### NO internal DC Fuses.

In order to fully utilize the full capacity of the product, batteries with sufficient capacity and battery cables with sufficient cross section should be used. See table below:

	12/2000/80	24/2000/50	48/2000/25
Recommended battery capacity (Ah)	350-1000	200-500	100-250
Recommended DC fuse	300A	200A	100A
Recommended cross section (mm <sup>2</sup> ) per + and - connection terminal			
0 – 5 m	70mm <sup>2</sup>	35 mm <sup>2</sup>	25 mm <sup>2</sup>
5 – 10 m	95mm <sup>2</sup>	70 mm <sup>2</sup>	50mm <sup>2</sup>

Remark: Internal resistance is the important factor when working with low capacity batteries. Please consult your supplier or the relevant sections of our book 'Energy Unlimited', downloadable from our website.

#### Procedure

Proceed as follows to connect the battery cables:



Use a torque wrench with insulated box spanner in order to avoid shorting the battery.

Recommended torque: 12 Nm (M8 nut)

Avoid shorting the battery cables.

- Undo the two screws at the bottom of the enclosure and remove the service panel.
- Connect the battery cables: see Appendix A.
- Tighten the nuts well for minimal contact resistance.

All servicing must be undertaken by qualified personnel.

### 4.3. Connection of the AC cabling



This is a Safety Class I product (supplied with a protective grounding terminal). **Uninterruptible protective grounding must be provided at the AC input and/or output terminals and/or chassis grounding point located externally on the product.**

The MultiPlus is provided with a ground relay (relay H, see appendix B) that automatically connects the Neutral output to the chassis if no external AC supply is available. If an external AC supply is provided, the ground relay H will open before the input safety relay closes. This ensures the correct operation of an earth leakage circuit breaker that is connected to the output.

- In a fixed installation, uninterruptible grounding can be secured by means of the grounding wire of the AC input. Otherwise the casing must be grounded.
- In a mobile installation, interrupting the shore connection will simultaneously disconnect the grounding connection. In that case, the casing must be connected to the chassis (of the vehicle) or to the hull or grounding plate (of the boat).
- In case of a boat, direct connection to the shore ground is not recommended because of potential galvanic corrosion. The solution to this is using an isolation transformer.

The mains input & output terminal connector can be found on the bottom of the MultiPlus, see appendix A. The shore or mains cable must be connected to the connector with a three-wire cable. Use a three-wire cable with a flexible core and a cross section of at least 6 mm<sup>2</sup>. **Recommended torque: 1,6 Nm**

**Procedure (see appendix A) Do not invert neutral and phase when connecting the AC.**

The inverter does incorporate a mains frequency isolating transformer. This precludes the possibility of DC current at any AC port. Therefore type A RCD's can be used.

### 4.4. Optional Connections

A number of optional connections are possible:

Undo the four screws at the front of the enclosure and remove the front panel.

#### 4.4.1. Second Battery

The Multi has a connection (+) for charging a starter battery. For connection see appendix A.

Trickle charge output is protected by automatic overcurrent & overload protection (trip current 1A I<sub>max</sub>= 5,5A)

#### 4.4.2. Temperature Sensor

The temperature sensor supplied with the product may be used for temperature-compensated charging. The sensor is insulated and must be mounted on the battery minus pole. Default output voltages for Float and Absorption are at 25°C. In adjust mode temperature compensation is disabled.

#### 4.4.3. Remote Control

The product can be remotely controlled in two ways:

- With an external on/off switch (Remove Link "Remote Switch connector H")
- With a Multi Control Panel

Please see section 5.4 for appropriate DIP switch settings.

#### 4.4.4. Programmable relay

The MultiPlus is equipped with a multi-functional relay that by default is programmed as an alarm relay. The relay can be programmed for all kinds of other applications however, for example to start a generator (VEConfigure software needed).

#### 4.4.5. Parallel Connection (see appendix C)

The MultiPlus can be connected in parallel with several identical devices. To this end, a connection is established between the devices by means of standard RJ45 UTP cables. The system (one or more MultiPlus units plus optional control panel) will require subsequent configuration (see Section 5).

In the event of connecting MultiPlus units in parallel, the following requirements must be met:

- A maximum of six units connected in parallel.
- Only identical devices may be connected in parallel.

- The DC connection cables to the devices must be of equal length and cross-section.
- If a positive and a negative DC distribution point is used, the cross-section of the connection between the batteries and the DC distribution point must at least equal the sum of the required cross-sections of the connections between the distribution point and the MultiPlus units.
- Place the MultiPlus units close to each other, but allow at least 10 cm for ventilation purposes under, above and beside the units.
- A battery-temperature sensor need only be connected to one unit in the system. If the temperature of several batteries is to be measured, you can also connect the sensors of other MultiPlus units in the system (with a maximum of one sensor per MultiPlus). Temperature compensation during battery charging responds to the sensor indicating the highest temperature.
- Only one remote can be connected to the system.

#### **4.4.6. Three-phase operation (see appendix D)**

The MultiPlus can also be used in 3-phase wye (Y) configuration. To this end, a connection between the devices is made by means of standard RJ45 UTP cables (the same as for parallel operation). The system (MultiPlus units plus an optional control panel) will require subsequently configuration (see Section 5).

Pre-requisites: see Section 4.4.5.

## 5. Configuration



Settings may only be changed by a qualified engineer.  
Carefully read the instructions before changes are made.  
Batteries should be placed in a dry and well-ventilated area during charging.

### 5.1. Standard settings: ready for use

On delivery, the MultiPlus is set to standard factory values. In general, these settings are suitable for single-unit operation.



Possibly, the standard battery charging voltage is not suitable for your batteries! Refer to the manufacturer's documentation or to your battery supplier!

#### Standard MultiPlus factory settings

Inverter frequency	
Input frequency range	
Input voltage range	
Inverter voltage	
Stand-alone / parallel / 3-phase	stand-alone
Search mode	off
Ground relay	on
Charger on/ off	on
Battery charge algorithm	four-stage adaptive with BatterySafe mode
Charge current	100% of the maximum charge current
Battery type	Victron Gel Deep Discharge (also suitable for Victron AGM Deep Discharge)
Automatic equalisation charging	off
Absorption voltage	14.4 / 28.8 / 57.6V
Absorption time	up to 8 hours (depending on bulk time)
Float voltage	13.8 / 27.6 / 55.2V
Storage voltage	13.2 / 26.4 / 52.8V (not adjustable)
Repeated absorption time	1 hour
Absorption repeat interval	7 days
Bulk protection	off
AC input current limit	
UPS feature	on
Dynamic current limiter	off
WeakAC	off
BoostFactor	2
Programmable relay	alarm function

### 5.2. Explanation of settings

Settings that are not self-explanatory are described briefly below. For further information, please refer to the help files in the software configuration programs (see Section 5.3).

#### Inverter frequency

Output frequency if no AC is present at the input.

#### Input frequency range

Input frequency range accepted by the MultiPlus. The MultiPlus synchronises within this range with the AC input frequency. The output frequency is then equal to the input frequency.

**Input voltage range**

Voltage range accepted by the MultiPlus. The MultiPlus synchronises within this range with the AC input voltage. The output voltage is then equal to the input voltage.

Adjustability:

**Inverter voltage**

Output voltage of the MultiPlus in battery operation.

**Stand-alone / parallel operation / 2-3 phase setting**

Using several devices, it is possible to:

increase total inverter power (several devices in parallel)

create a split-phase system

create a 3-phase system.

The standard product settings are for standalone operation. For parallel, or three phase operation see section 4.4.5 and 4.4.6.

**Search mode**

If search mode is 'on', the power consumption in no-load operation is decreased by approx. 70%. In this mode the MultiPlus, when operating in inverter mode, is switched off in case of no load or very low load, and switches on every two seconds for a short period. If the output current exceeds a set level, the inverter will continue to operate. If not, the inverter will shut down again.

Search Mode can be set with a DIP switch.

Search Mode 'shut down' and 'remain on' load levels can be set with VEConfigure.

The standard settings are:

**AES (Automatic Economy Switch)**

Instead of the search mode, the AES mode can also be chosen (with help of VEConfigure only).

If this setting is turned 'on', the power consumption in no-load operation and with low loads is decreased by approx. 20%, by slightly 'narrowing' the sinusoidal voltage.

**Ground relay (see appendix B)**

With this relay (H), the neutral conductor of the AC output is grounded to the chassis when the back-feed safety relay is open. This ensures the correct operation of earth leakage circuit breakers in the output.

If a non-grounded output is required during inverter operation, this function must be turned off. (Use VEConfigure)

The standard setting is 'Four-stage adaptive with BatterySafe mode'. See Section 2 for a description.

This is the recommended charge curve. See the help files in the software configuration programs for other features.

**Battery type**

The standard setting is the most suitable for Victron Gel Deep Discharge, Gel Exide A200, and tubular plate stationary batteries (OPzS). This setting can also be used for many other batteries: e.g. Victron AGM Deep Discharge and other AGM batteries, and many types of flat-plate flooded batteries. Four charging voltages can be set with DIP switches.

**Automatic equalisation charging**

This setting is intended for tubular plate traction batteries. During absorption the voltage limit increases to 2,83V/cell (34V for a 24V battery) once the charge current has tapered down to less than 10% of the set maximum current.

**Absorption time**

The absorption time depends on the bulk time (adaptive charge curve), so that the battery is optimally charged. If the 'fixed' charging characteristic is selected, the absorption time is fixed. For most batteries, a maximum absorption time of eight hours is suitable. If an extra high absorption voltage is selected for rapid charging (only possible for open, flooded batteries!), four hours is preferable. With DIP switches, a time of eight or four hours can be set. For the adaptive charge curve, this determines the maximum absorption time.

**Storage voltage, Repeated Absorption Time, Absorption Repeat Interval**

See Section 2.

**Bulk Protection**

Default setting: off. When this setting is 'on', the bulk charging time is limited to 10 hours. A longer charging time could indicate a system error (e.g. a battery cell short-circuit).

**AC input current limit**

See Section 2, the book 'Energy Unlimited', or the many descriptions of this unique feature on our website [www.victronenergy.com](http://www.victronenergy.com).

#### UPS feature

If this setting is 'on' and AC on the input fails, the MultiPlus switches to inverter operation practically without interruption. The MultiPlus can therefore be used as an Uninterruptible Power Supply (UPS) for sensitive equipment such as computers or communication systems. The output voltage of some small generator sets is too unstable and distorted for using this setting\* – the MultiPlus would continually switch to inverter operation. For this reason, the setting can be turned off. The MultiPlus will then respond less quickly to AC input voltage deviations. The switchover time to inverter operation is consequently slightly longer, but most equipment (most computers, clocks or household equipment) is not adversely impacted. Recommendation: Turn the UPS feature off if the MultiPlus fails to synchronise, or continually switches back to inverter operation.

\*In general, the UPS setting can be left 'on' if the MultiPlus is connected to a generator with a 'synchronous AVR regulated alternator'.

The UPS mode may have to be set to 'off' if the MultiPlus is connected to a generator with a 'synchronous capacitor regulated alternator' or an asynchronous alternator.

#### Dynamic current limiter

Intended for generators, the AC voltage being generated by means of a static inverter (so-called 'inverter' generators). In these generators, rpm is down-controlled if the load is low: this reduces noise, fuel consumption and pollution. A disadvantage is that the output voltage will drop severely or even completely fail in the event of a sudden load increase.

More load can only be supplied after the engine is up to speed.

If this setting is 'on', the MultiPlus will reduce charge current until the set current limit is reached. This allows the generator engine to get up to speed.

This setting is also often used for 'classic' generators that respond slowly to sudden load variation.

#### WeakAC

Strong distortion of the input voltage can result in the charger hardly operating or not operating at all. If WeakAC is set, the charger will also accept a strongly distorted voltage, at the cost of greater distortion of the input current.

Recommendation: Turn WeakAC on if the charger is hardly charging or not charging at all (which is quite rare!). Also turn on the dynamic current limiter simultaneously and reduce the maximum charging current to prevent overloading the generator if necessary.

#### BoostFactor

Change this setting only after consulting with Victron Energy or with an engineer trained by Victron Energy!

#### Programmable relay

By default, the programmable relay is set as an alarm relay, i.e. the relay will de-energise in the event of an alarm or a pre-alarm (inverter almost too hot, ripple on the input almost too high, battery voltage almost too low).

#### VEConfigure software

With VEConfigure software the relay can also be programmed for other purposes, for example to provide a generator starting signal.

## 5.3. Configuration of the MultiPlus

The following hardware is required:

A MK3-USB (VE.Bus to USB) interface.

Alternatively, the Interface MK2.2b (VE.Bus to RS232) can be used (RJ45 UTP cable needed).

### 5.3.1. VE.Bus Quick Configure Setup

**VE.Bus Quick Configure Setup** is a software program with which systems with a maximum of three MultiPlusses (parallel or three phase operation) can be configured in a simple manner. The software can be downloaded free of charge at [www.victronenergy.com](http://www.victronenergy.com).

### 5.3.2. VE.Bus System Configurator

For configuring advanced applications and/or systems with four or more MultiPlusses, **VE.Bus System Configurator** software must be used. The software can be downloaded free of charge at [www.victronenergy.com](http://www.victronenergy.com)

## 5.4. Configuration with DIP switches

Some settings can be changed with DIP switches.

Procedure:

- a) Turn the MultiPlus on, preferably without load and without AC voltage on the input. The MultiPlus will then operate in inverter mode.
- b) Set the DIP switches as required.
- c) Store the settings by toggling DIP switch 3 one time.

#### 5.4.1. DIP switch 1 to 3

These DIP switches can be used to set:

- Battery charge voltage and Absorption time
- Search mode

**Ds1-ds2: Setting the charge algorithm** (For more system settings use VEConfigure)

Ds1-ds2	Absorption voltage	Float voltage	Storage Voltage	Absorption Time (hours)	Suitable for
Ds1=off Ds2=off (default)	14.4 28.8 57.6	13.8 27.6 55.2	13.2 26.4 52.8	8	Gel Victron Deep Discharge Gel Exide A200 AGM Victron Deep Discharge
Ds1=on Ds2=off	14.1 28.2 56.4	13.8 27.6 55.2	13.2 26.4 52.8	8	Gel Victron Long Life (OPzV) Gel Exide A600 (OPzV) Gel MK battery Li-ion (LiFePO4)
Ds1=off Ds2=on	14.7 29.4 58.8	13.8 27.6 55.2	13.2 26.4 52.8	5	AGM Victron Deep Discharge Tubular plate or OPzS batteries in semi-float mode AGM spiral cell
Ds1=on Ds2=on	15.0 30.0 60.0	13.8 27.6 55.2	13.2 26.4 52.8	6	Tubular plate or OPzS batteries in cyclic mode

DS3 double function.

**Ds3: Search Mode and store**    off = off    on = on

Store the settings by toggling DIP switch 3 one time.

#### 5.4.2. Exemplary settings

Example 1 is the factory setting (since factory settings are entered by computer, all DIP switches of a new product are set to 'off').

DS-1 Charge voltage	off	DS-1 DS-2	off on	DS-1 DS-2	on on
DS-2 Charge voltage	off	DS-2	off	DS-3	on
DS-3 Charge voltage	off				

Example 1: (factory setting)	Example 2	Example 3
1.2 GEL 14.4 V	1.2 Gel Victron Long Life	1.2 Tubular plate 15V
3 Search mode off	Li-ion (LiFePO4)	3 Search mode off
3 Store setting: off→ on→ off	3 Search mode off	3 Store setting: off→ on→ off
	3 Store setting: off→ on→ off	

Store the settings by toggling DIP switch 3 one time.

The LEDs 'charger' and 'alarm' will flash to indicate acceptance of the settings.

## 6. Maintenance

The MultiPlus does not require specific maintenance. All maintenance should be performed by qualified personnel. Avoid moisture and oil/soot/vapours, and keep the device clean.

## 7. Trouble Shooting Table

Proceed as follows for quick detection of common faults.

DC loads must be disconnected from the batteries and the AC loads must be disconnected from the inverter before the inverter and/or battery charger is tested.

Consult your Victron Energy dealer if the fault cannot be resolved.

Problem	Cause	Solution
The inverter fails to operate when switched on	The battery voltage is too high or too low	Ensure that the battery voltage is within the correct value.
The inverter fails to operate	Processor in no function-mode	Disconnect mains voltage. Switch front switch off, wait 4 seconds. Switch front switch on.
The alarm LED flashes	Pre-alarm alt. 1. The DC input voltage is low	Charge the battery or check the battery connections.
The alarm LED flashes	Pre-alarm alt. 2. The ambient temperature is too high	Place the inverter in a cool and well-ventilated room, or reduce the load.
The alarm LED flashes	Pre-alarm alt. 3. The load on the inverter is higher than the nominal load	Reduce the load.
The alarm LED flashes	Pre-alarm alt. 4. Voltage ripple on the DC input exceeds 1.25Vrms	Check the battery cables and terminals. Check the battery capacity; increase if necessary.
The alarm LED flashes intermittently	Pre-alarm alt. 5. Low battery voltage and excessive load	Charge the batteries, reduce the load or install batteries with a higher capacity. Use shorter and/or thicker battery cables.
The alarm LED is on	The inverter did cut out following a pre-alarm	Check the table for the appropriate course of action.
The charger is not functioning	The AC input voltage or frequency is out of range	Ensure that the input voltage is between 185Vac and 265Vac, and that the frequency matches the setting.
The battery is not being charged fully	Incorrect charging current	Set the charging current at between 0.1 and 0.2x battery capacity.
	A defective battery connection	Check the battery terminals.
	The absorption voltage has been set to an incorrect value	Adjust the absorption voltage to the correct value.
	The float voltage has been set to an incorrect value	Adjust the float voltage to the correct value.
	The internal DC fuse is defective	Inverter is damaged.
The battery is overcharged	The absorption voltage has been set to an incorrect value	Adjust the absorption voltage to the correct value.
	The float voltage has been set to an incorrect value	Adjust the float voltage to the correct value.
	A defective battery	Replace the battery.
	The battery is too small	Reduce the charging current or use a battery with a higher capacity.
	The battery is too hot	Connect a temperature sensor.
Battery charge current drops to 0 when the absorption voltage is reached	Alt. 1: Battery overtemperature (> 50°C)	<ul style="list-style-type: none"> <li>Allow battery to cool down</li> <li>Place battery in a cool environment</li> <li>Check for shorted cells</li> </ul>

Problem	Cause	Solution
	Alt 2: Battery temperature sensor faulty	<p>Unplug battery temperature sensor from the MultiPlus.</p> <p>Reset the MultiPlus by switching it off, then wait for 4 seconds and switch it on again.</p> <p>If the MultiPlus now charges normally, the battery temperature sensor is faulty and needs to be replaced.</p>

## 8. APPENDIX

### 8.1. Appendix A: overview connections

	EN
A	DIP switch Remove cover
B	On/off/charger only switch
C	VE.BUS Communications port
D	Temperature sensor
E	Alarm contact
F	Batterie Minus
G	Starter battery plus
H	Remote control
I	Mains IN
J	Mains/converter OUT
K	Battery plus
L	Earth connection

### 8.2. Appendix B: installation information

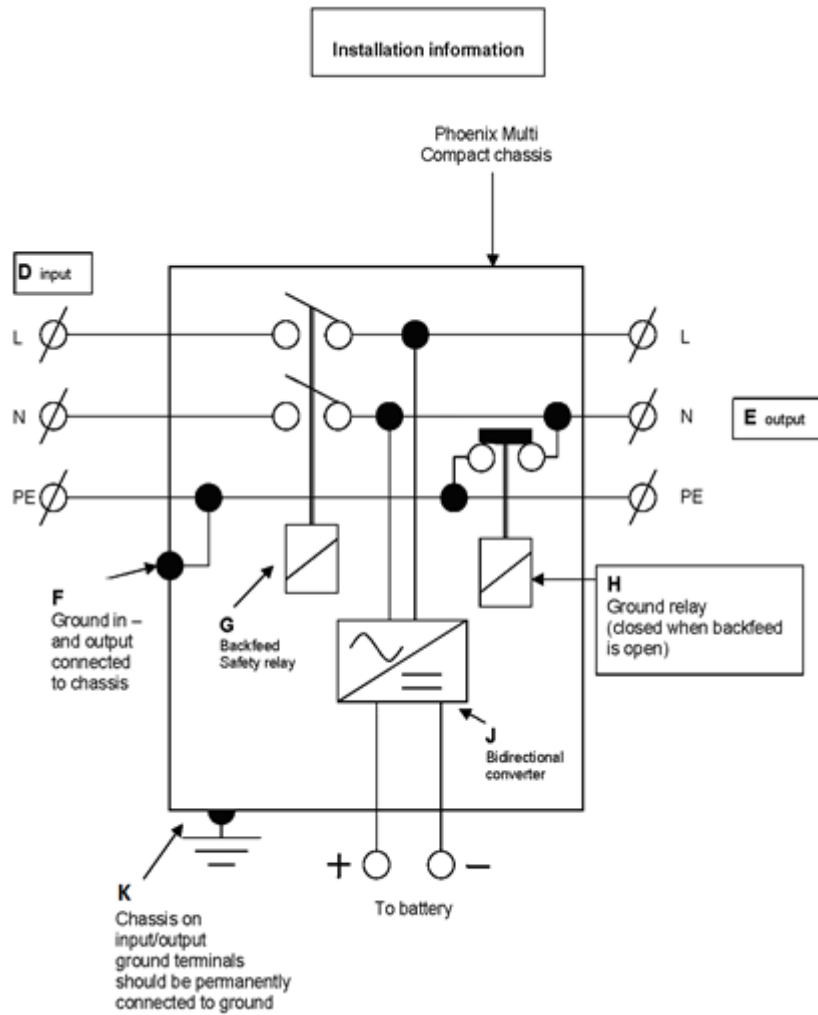

EN	
D	Input
E	Output
F	Ground in– and output connected to chassis
G	Backfeed safety relay
H	Ground relay (closed when backfeed is open)
J	Bidirectional converter
K	Chassis on input/output ground terminals should be permanently connected to ground

### 8.3. Appendix C: parallel connection

### 8.4. Appendix D: three-phase connection

## 8.5. Appendix E: charge algorithm

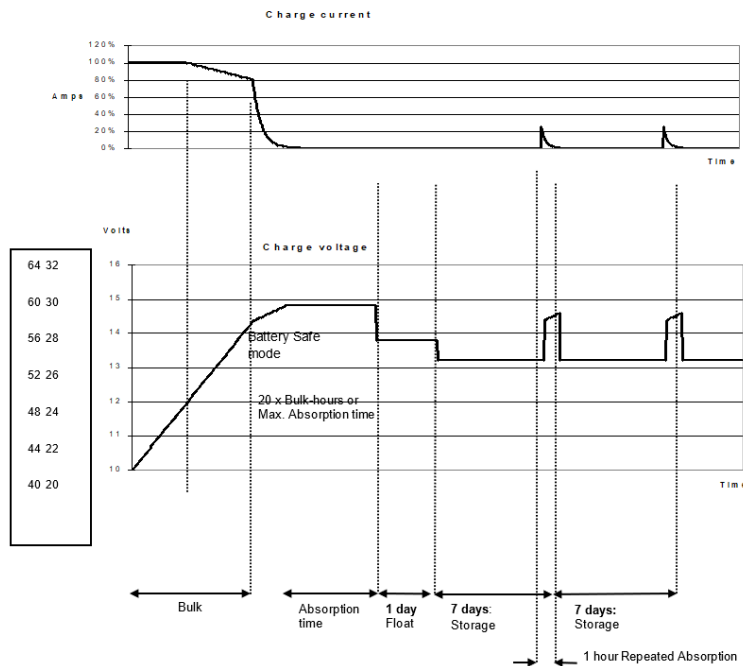

### 4-stage charging:

**Bulk:** Entered when charger is started. Constant current is applied until the gassing voltage is reached (14.4V resp. 28.8V, temperature compensated).

**Battery Safe:** If, in order to quickly charge a battery, a high charge current in combination with a high absorption voltage has been chosen, the Multi will prevent damage due to excessive gassing by automatically limiting the rate of voltage increase once the gassing voltage has been reached. The Battery Safe period is part of the calculated absorption time.

**Absorption:** A constant voltage period to fully charge the battery. The absorption time is equal to 20x bulk time or the set maximum absorption time, whichever comes first.

**Float:** Float voltage is applied to keep the battery fully charged and to protect it against self-discharge.

**Storage:** After one day of Float charge the charger switches to storage. This is 13,2V resp. 26,4V (for 12V and 24V charger). This will limit water loss to a minimum. After an adjustable time (default = 7 days) the charger will enter Repeated Absorption for an adjustable time (default = 1 hour).

## 8.6. Appendix F: temperature compensation

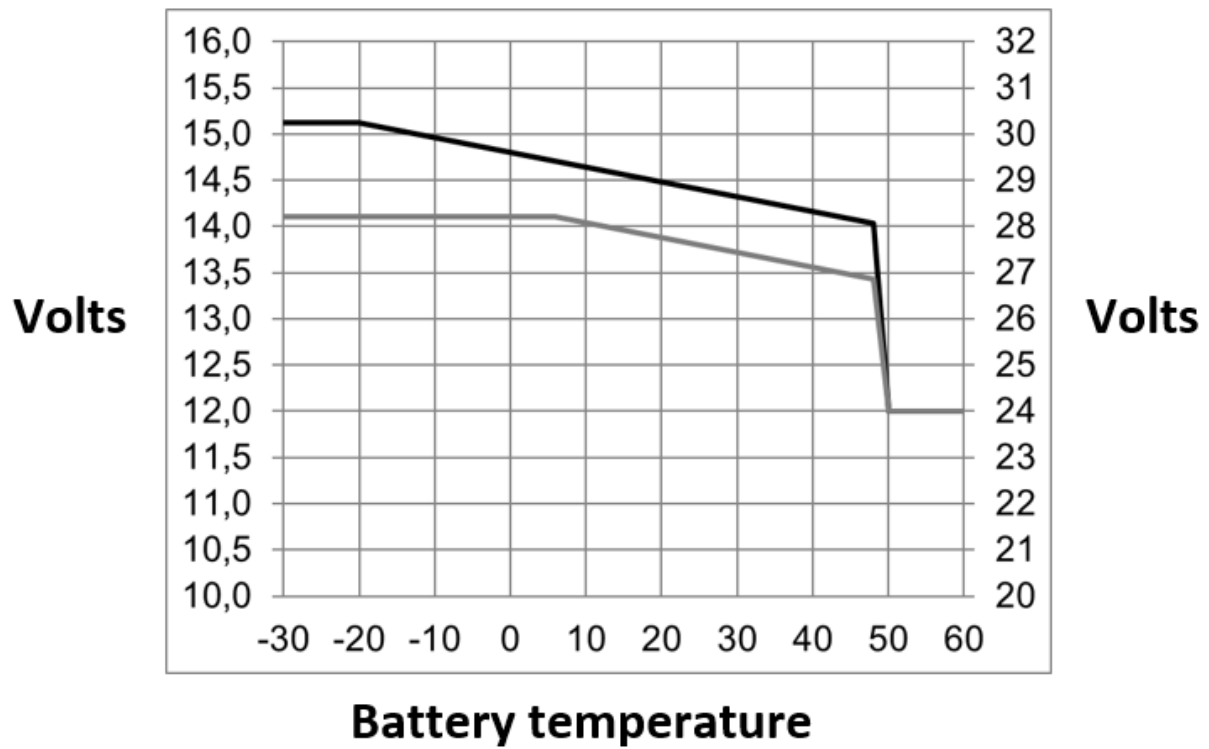

Default output voltages for Float and Absorption are at 25°C.

Reduced Float voltage follows Float voltage and Raised Absorption voltage follows Absorption voltage.

In adjust mode temperature compensation does not apply.

### 8.7. Appendix G: dimensions

